

TABLES BY
PRISMATIQUE

**Effective
October 1, 2020
Add 8% To All
List Prices**

**OCTOBER 2018
SPECIFICATIONS
AND INTERIM
LIST PRICEBOOK**

SURFACE FINISHES

WOOD VENEERS • HARDWOOD EDGES

General Info

Veneer tops and hardwood edges are available in all flat cut species.

Top surfaces are book matched Architectural Grade A Veneers; lesser quality veneers are bonded to underside of tops for balance. Top finish is semi-open, medium sheen, clear catalyzed lacquer.

Refer to VENEER BROCHURE for standard finishes.

Custom Stains and Veneers

Custom stain charge is \$350.00 NET for set-up and \$50.00 NET per unit.

Premium veneers such as Sycamore, Anigre, Bird's Eye Maple and Curly Maple are available at an upcharge.

Maintenance

Clean with mild soap and water. Wipe dry with pattern direction. Do not use abrasive cleaners or wax.

PLASTIC LAMINATES

General Info

High pressure plastic laminates in solids, patterns and woodgrains from Formica, Wilsonart, Nevamar and Pionite are available in matte finishes and represent our standard list prices. Premium priced laminates within these lines are subject to an upcharge. For these or laminates from other manufacturers such as Laminart or Abet, upcharge will apply.

Laminate tops with COLORA or wood edge feature an 1/8" dia. COLORA Inlay.

Pionite 800 746-6483 Std=all "- Suede" laminates.

Nevamar 800 638-4380 Std=all "- T" laminates.

Wilsonart 800 433-3222 Std=all "- 60" laminates.

Formica 800 FORMICA Std=all "- 58" laminates.

Vinyl Edge

Flat Vinyl edges are available in 15 standard colors. Custom color charge is \$665.00 NET. and minimum 2,500 LF order.

EFFECTIVE FEBRUARY 1, 2015
VINYL EDGE PROFILE CHANGE:

Old style may be ordered at same price until inventory is depleted. Upcharges will then apply.

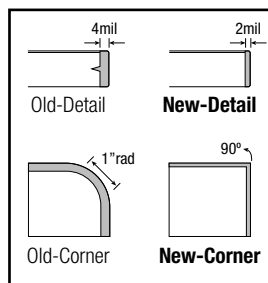

COLORA

General Info

COLORA is a textured polyurethane material applied to MDF board in two steps.

Although highly durable, COLORA surfaces are not as hard as laminates. It is applied to table tops, edges, bases and cabinets. COLORA is available in 15 standard colors. Custom color charge is \$350.00 NET per color mix.

Maintenance

Clean with mild soap and water. Do not use abrasive cleaners or wax.

STONE

General Info

Standard marble and granite varieties are shown in the STONE BROCHURE.

Prismatique will make available most stones specified by customer, often at no upcharge. Stone surfaces vary greatly in color, texture, pattern and quality. Marble in particular is seldom free of fine cracks or other imperfections. All stone surfaces have natural polish. All stone tops are supplied with black painted plywood subtops.

Maintenance

Clean with mild soap and water. Do not use abrasive cleaners. Regular waxing of marble (only) surfaces is recommended.

GLASS

General Info

Light scratches, waves or tiny bubbles are inherent to glass fabrication and to be expected. Vidro Painted Back Glass tops offer simple color (all standard 15 color colors) in Clear (CL) and Matte/Etched (MA) or ceramic frit printed (Vidro Art). Custom color charge is \$670.00 NET per color.

Maintenance Clean with commercial glass cleaner only.

TOP-EDGE CONFIGURATIONS

VENEER TOPS are 1" thick (3/4" Parsons) medium or high density particleboard core edged with hardwood or COLORA colors.

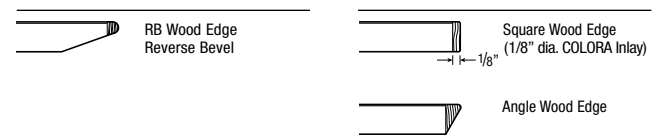

LAMINATE TOPS are 1" thick (3/4" for Whitby and Parsons) medium or high density particleboard core edged with hardwood, vinyl or COLORA colors.

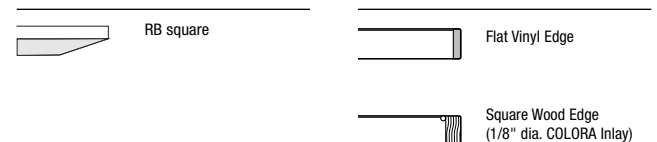

COLORA TOPS are 1" thick (3/4" Parsons) high density particleboard with self or hardwood edges.

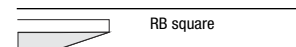

STONE TOPS are 3/4" thick with same or built-up edges

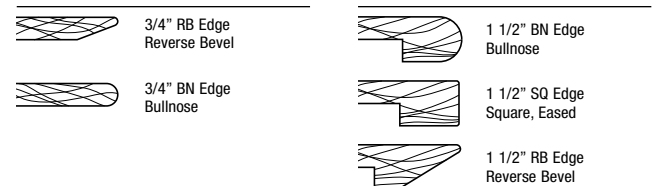

VIDRO PAINTED BACK GLASS TOPS are 1 1/4" thick with starphire glass adhered to MDF subtop available in any color - clear or matte finish.

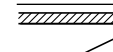

OTHER GLASS TOPS are 1/2" or 3/4" thick and are clear or sandblasted

Occasionals

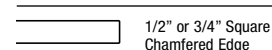

WOODGRAIN DIRECTION ON VENEER and LAMINATE TOPS

Grain directions on wood veneer and wood pattern laminate table tops vary according to size, shape and configuration. Every effort is made to ensure continuation of wood grain direction and pattern, and consistency of stain and sheen on sectioned-top meeting tables and ganged configurations of modular tables.

MEETING TABLES

All shapes of table tops that are 96" or smaller have Length Grain – wood grain runs parallel to length of top. Table tops in one or more sections, 108"L or larger have Width Grain – wood grain runs across the width of top. Sectioned tops utilize Same-Flitch Veneers to ensure consistent grain pattern.

LENGTH GRAIN TOPS WIDTH GRAIN TOPS

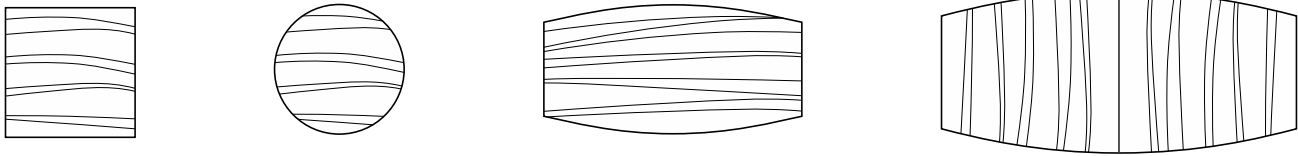

ARTICULATING TABLES

Articulating table tops are uniformly Length Grain. 144" and 180"L tops are sectioned and End-Matched as close as possible.

LENGTH GRAIN TOPS



MODULAR TABLES

Modular tables utilize Same-Flitch Veneers or wood grain laminates with same pattern, color and sheen and are consistently Side- or End-Matched depending on the table configuration. Grain directions and/or Side- or End-Matching can be customized – an upcharge applies.

SIDE-MATCHED TABLE LAYOUTS

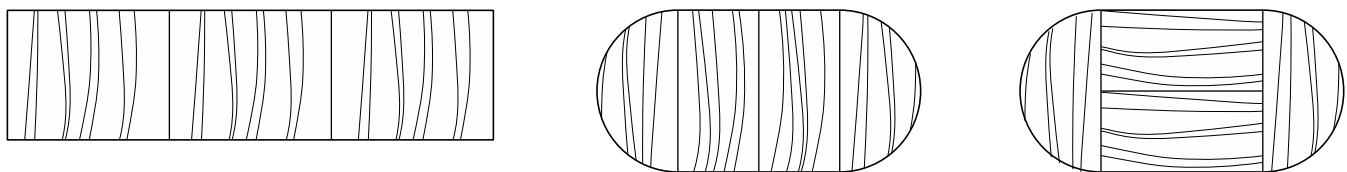

END-MATCHED TABLE LAYOUTS

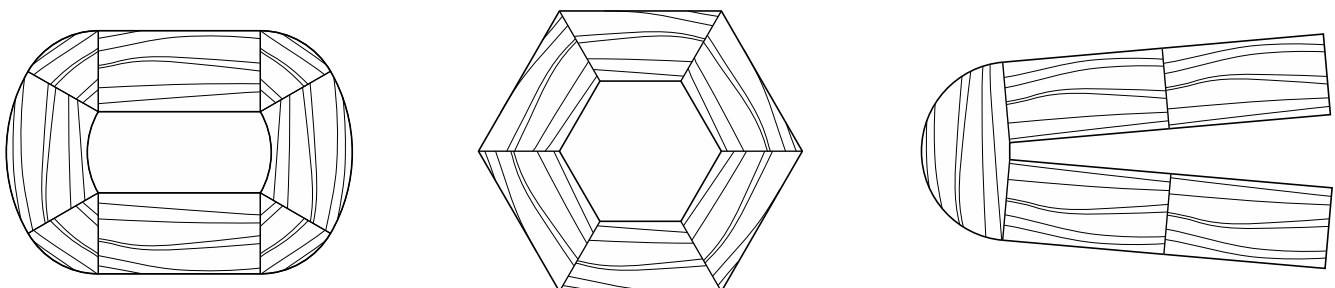

TABLE BASES AND MODESTY PANELS • CONSTRUCTION AND FINISHES

TABLE BASES • METAL

For the most part, table bases incorporate various gauges of sheet, barstock or tubular steel and extruded or cast aluminum components. Tubular steel in square or round profiles are utilized for T-, C- and Cross shapes. Sheet steel is rolled to form Drum bases and Occasional Metal Drum Tables. Barstock steel, rolled and welded is used for base elements of Konverse, T and Cross tables and Ronde series. Mounting top plates in various sizes and meeting table underframes are constructed with sheet and tubular steel respectively. Stainless sheets are applied to wood cores in production of Occasional Metal Cube Tables. Infinity series incorporate extruded columns and cast aluminum components in Column, T and C base styles. Panel base trim and Marker Board frame are extruded aluminum. Steel and aluminum bases, connector plates, top support rails and flip top mechanism are coated with COLORA colors. Certain table series also offer plated finishes on steel.

TABLE BASES • WOOD

Whitby table legs and apron are solid maple available in clear or stained finishes. Cube bases are medium or high-density particleboard in COLORA colors or veneers. Wood veneers are laminated to wood core in Occasional Drum tables and steel core in Drum bases.

MODESTY PANELS

Flat, Flat Folding and J Modesty Panels, Articulating, Training and Modular tables are formed or extruded aluminum. Flat Modesty is bolted to underside of top and requires tools for installation and removal. Flat Folding Modesty folds under and parallel to table underside and features an optional wire manager. J Modesty is in ribbed pattern, contains a large wire through and is removable without tools. J Modesty is available up to 10' long. All panels are finished in COLORA colors to match table bases unless specified otherwise.

FINISHES

Colora

COLORA is a textured polyurethane material applied to steel and aluminum in two steps. It is scratch-resistant and stain proof. COLORA is leather-like in appearance and seamless. COLORA is available in 15 standard colors. Custom color charge is \$350.00 NET per color mix.

High Gloss Colora

Higher sheen finish to all 15 standard COLORA colors. Upcharge applies, requires quotation.

Acrylic Colora • Gilded Collection

Illuminous, metal like finish in a series of colors. Upcharge applies, requires quotation.

Plated Finishes • Chrome

Chrome in polished (mirror) or satin finishes is applied to steel base components where noted.

Stainless Steel

Blade, NEXTT and all Parsons bases are stainless steel construction offered in polished or brushed finish.

Maintenance

COLORA and plated steel surfaces can be cleaned with mild soap solution or glass cleaner and wiped dry with soft cloth. Do not apply abrasive cleaners, polish or lubricants to table bases or mechanical parts.

SELECTED COMPONENT FEATURES and SPECIFICATIONS



Flip Top • Double Base

Rigid and simple to operate heavy duty flip top assembly comprised of tubular and formed steel components painted in same color as bases and 2 levers which operate the double-engaging locking system. Flip top option is available for virtually all modular table shapes and meeting tables up to 8' long. Flip top tables are shipped assembled.



Folding Modesty

Flat pattern aluminum in 15 COLORA colors. Hinge mechanism provides articulation to fixed or folding (over table bases) positions. Optional plastic wire manager. Dimensions: 9" high x 60" or 72" long.



Flip Top • Single Base

Multipurpose Round and Square tables are optionally equipped with flip mechanism constructed of steel which hinges open like clam shell upon rotation of handle bar. Safety latch locks top in flat and open positions. Finished in same color as table base.



Fixed Modesty

Flat pattern aluminum panel in 15 COLORA colors is bolted to underside of tabletop. Dimensions: 9" high x 42" – 84" long.



Nesting 1

Modular/Training tables with Flat Folding Modesty require small amount of space for storage when not in use.



J Modesty

Extruded aluminum in ribbed pattern, features a large divided wire management tray. Removable without tools. Available in 15 COLORA colors. Dimensions: 7 1/2" high x 42" – 120" long.



Nesting 2

Modular / Training tables with J Modesty (or fixed Flat Modesty) require no additional nesting space.



Glides

All table bases (except the Occasionals) provide up to 3/4" height adjustability. Depending on table series, glides are black, 1" to 1 3/4" dia.

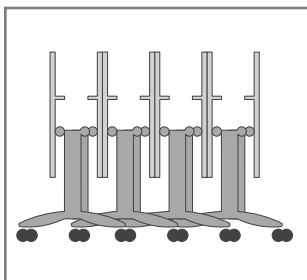

Nesting 3

Back-to-back table nesting allows storing more tables in less space. Calculate recommended space required for 8 nested tables by 9' x Table Length.



Casters

Locking casters are available for most table series. They must be specified at time of order. Caster option does not change height of tables. Infinity: 3" dia., black with silver brake. AV Carts, Lectern: 3" dia. Frames: 3" dia., Silver face with black lining and brakes. Low rise casters (optional): 1 1/2" dia.



Folding Base

Heavy duty construction with nylon injected molded frame and an extruded aluminum mechanism. Single press-down lever; can be operated by hand or foot. Positive lock in folded or upright positions. Black finish. Bases lay flat on tables as short as 56"L. Folding base tables are shipped assembled.

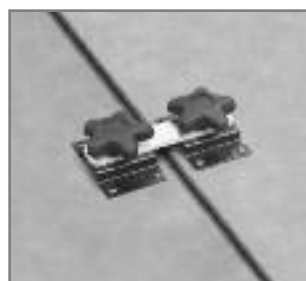

Gang Set

Each set consists of two brackets, a linking bar and two thumb screws. Gang Sets are utilized to link and level multiple table configurations. Ganging 20", 24", 30" and 36" sides require 1 set; 42" and over sides require 2 sets. No tools required for adjustment.

TABLE CARTS

Table carts are tubular steel construction in black finish and equipped with 5" dia. wheels.

TRH6 CART (removable bases only)

Stores 6 Tables without Modesty Panel. Base connector plates with bumper tipped inner columns remain attached to table undertops to protect tables during storage. Sets of Column or T Bases slide into rubber tipped shafts welded to Cart platform and stay upright between table tops.

Dimensions: 36" x 32 1/2" x 36" H

TRH6 CART

QTY1	QTY3	QTY10
2034	1881	1638

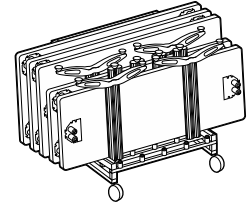
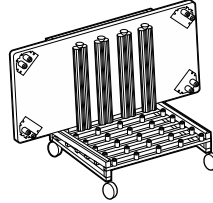
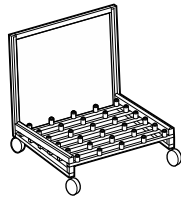

TRV6 CART

Stores 6 Tables with folding T or C bases with or without folding modesty. Also suitable for Tables with J Modesty Panel which user elects not to remove. Infinity Column or T Base store above table undertops. Max. table depth, 36".

Dimensions: 42" x 30" x 71" H

TRV6 CART

QTY1	QTY3	QTY10
1964	1740	1564

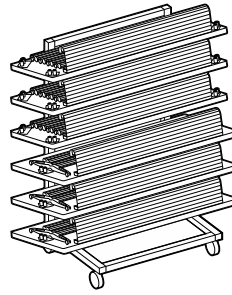
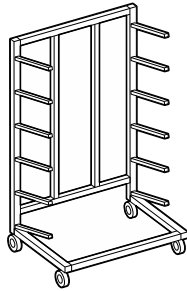

TR4 CART

Stores 4 Folding T or C Base Tables with or without Flat Folding Modesty or 4 GOSH! Folding (2" dia.) Column Base Tables. Cart length and divider heights vary depending on table dimensions. Minimum Door Clearance: 32" wide. Larger carts for 5 or more tables are customized according to door clearance.

Dimensions: 36" x 42" x 32" H

TR4 CART

QTY1	QTY3	QTY10
1740	1521	1423

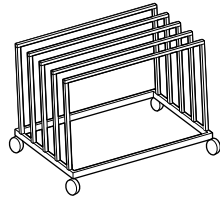

TVA CART!

Stores 4 Folding 4" dia. Column Base Tables

Dimensions: 52" x 30" x 41" H

TVA CART

QTY1	QTY3	QTY10
1964	1740	1564

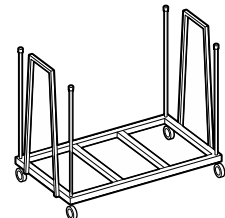

STANDARD POWER COMMUNICATION CABLE MANAGEMENT - DETAILS/TYPICALS

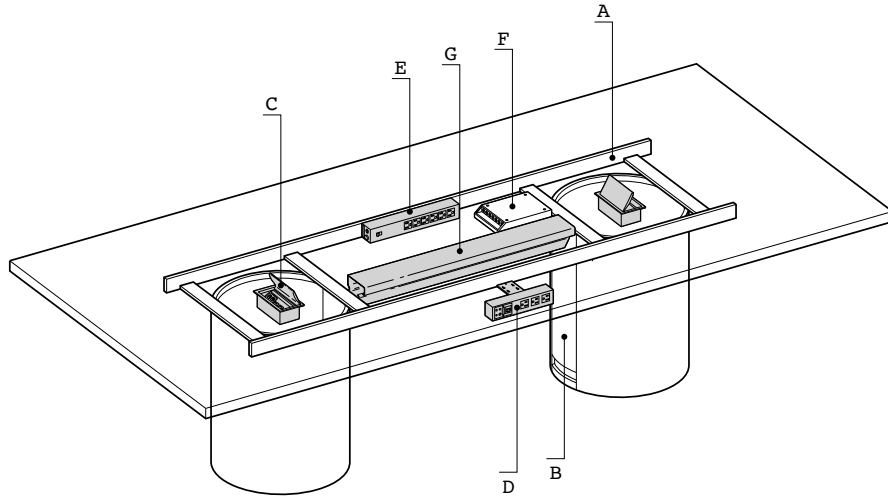

Drum Base • Wood, Vidro and Stone

- A Table Top Support Rail
- B Removable Base Access Panel
- C Surface Power Unit
- D Under top Power Unit
- E Surge Protected Power Bar
- F Data Hub (client supplied)
- G Large Wire Manager

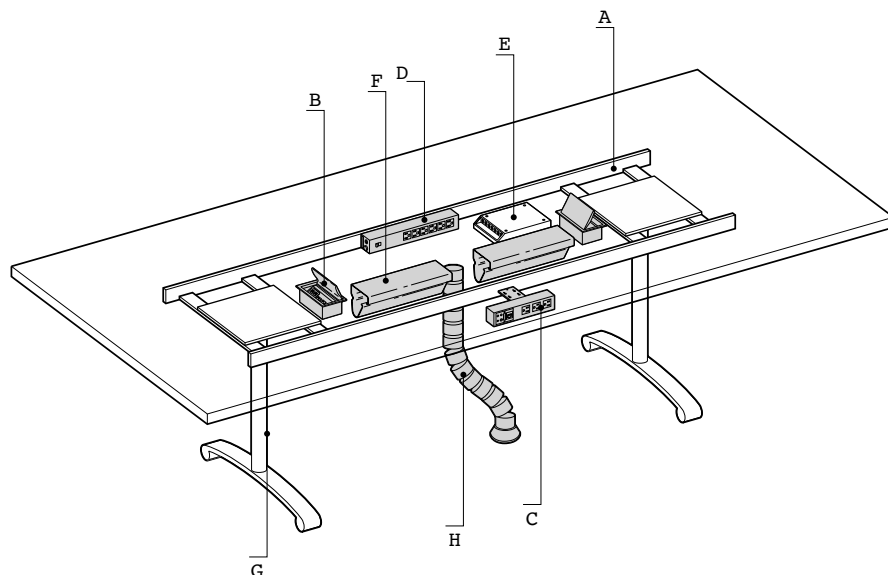

T Base • Wood, Vidro and Stone

- A Table Top Support Rail
- B Surface Power Unit
- C Under top Power Unit
- D Surge Protected Power Bar
- E Data Hub (client supplied)
- F Large Wire Manager
- G Snap-on Leg Wire Manager
- H Snake Wire Manager

STANDARD POWER COMMUNICATION CABLE MANAGEMENT - DETAILS/TYPICALS

Two surface power unit cables run through Large Wire Manager and routed down to floor level with Snake Manager.

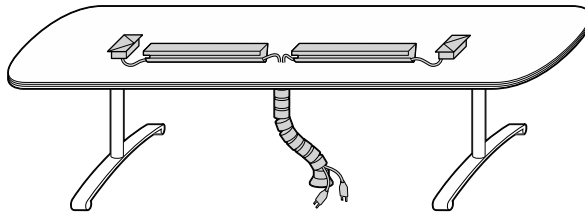

Three surface power units with three floor power sources. Large amounts of communication cables run inside Large Wire Manager.

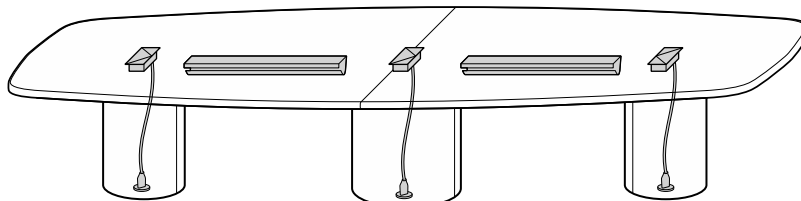

TRAINING TABLES - STANDARD CABLE MANAGEMENT - DETAILS/TYPICALS

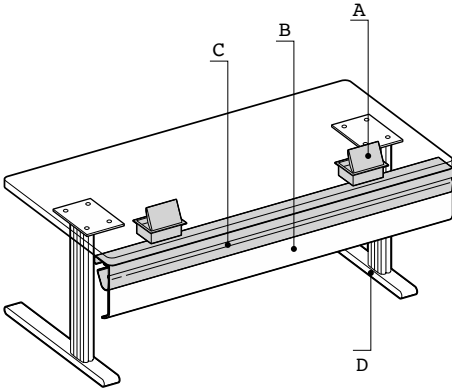

Nextt and Kable (shown)

C Base • Fixed

- A Surface Power Unit
- B Large Wire Manager
- C Flat Fixed Modesty
- D Removable Base Cover Strip

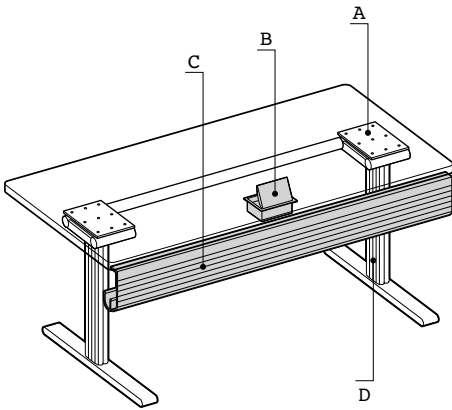

Nextt and Kable (shown)

T Base • Flip Top

- A Flip Top Mechanism
- B Surface Power Unit
- C J Modesty/Wire Bin
- D Removable Base Cover Strip

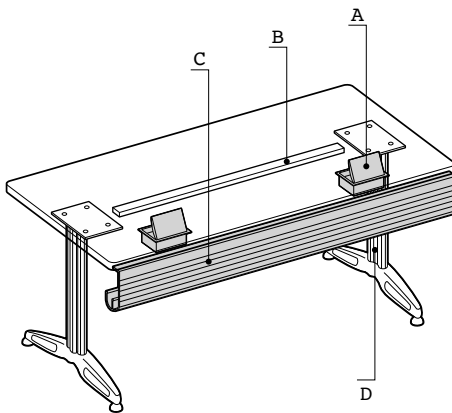

Infinity

T Base • Fixed

- A Top Support Rail (when required)
- B Surface Power Unit
- C J Modesty/Wire Bin
- D Removable Base Cover Strip

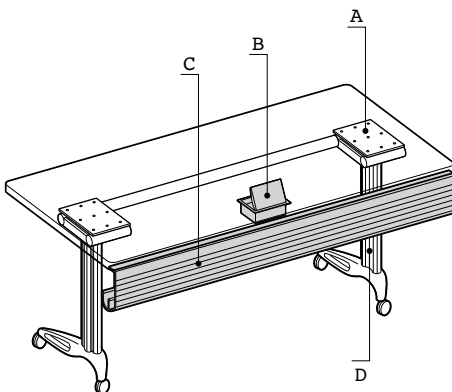

Infinity

C Base • Flip Top

- A Flip Top Mechanism
- B Surface Power Unit
- C J Modesty/Wire Bin
- D Removable Base Cover Strip

TYPICAL BASE and POWER UNIT LOCATIONS

DRUM BASE • WOOD, VIDRO AND STONE TOPS

Wood, Stone & Vidro
All sizes

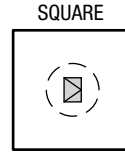
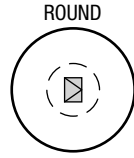

RECTANGLE - ARCED RECTANGLE - ARCED BOAT - ARCED WEDGE

Wood, Stone & Vidro **A**
84" x 42" 36"
96" x 48" 42"

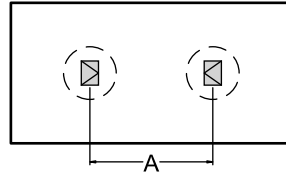
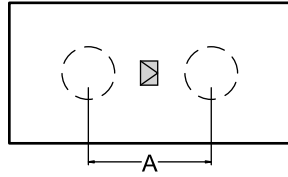

Wood **A**
108" x 48" 54"

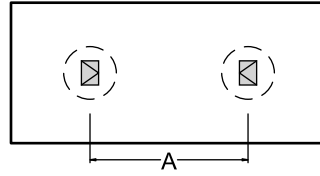
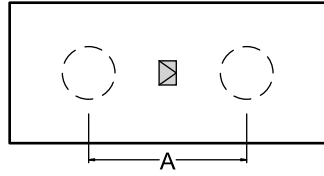

Stone & Vidro **A**
108" x 48" 54"

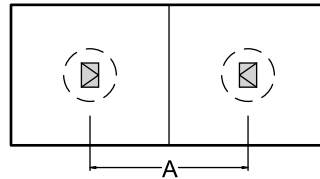
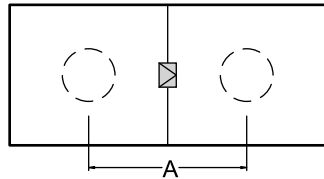

Wood, Stone & Vidro **A**
120" x 48" or 60" 56"
132" x 48" or 60" 68"
144" x 48" or 60" 78"

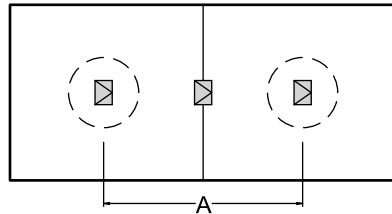
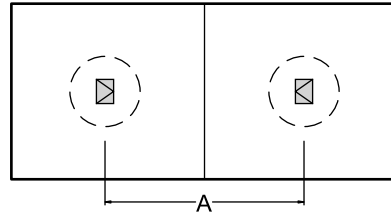
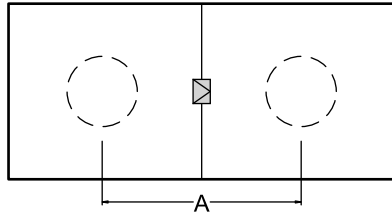

Wood, Stone & Vidro **A**
168" x 60" 52"

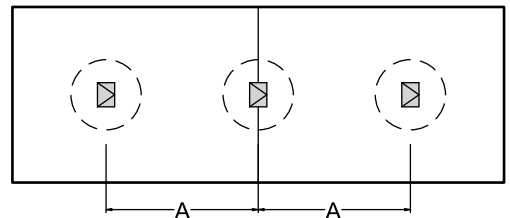
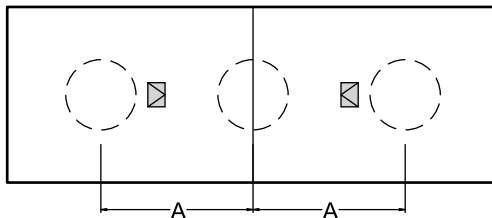

TYPICAL BASE and POWER UNIT LOCATIONS

DRUM BASE • WOOD, VIDRO AND STONE TOPS

RECTANGLE - ARCED RECTANGLE - ARCED BOAT - ARCED WEDGE

Wood Only
192" x 60"
216" x 60"

A
63"
74"

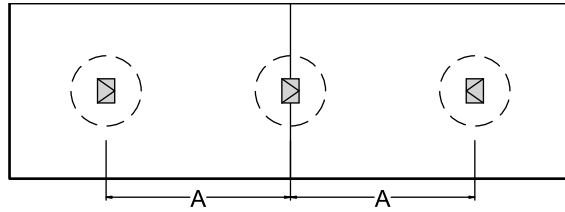
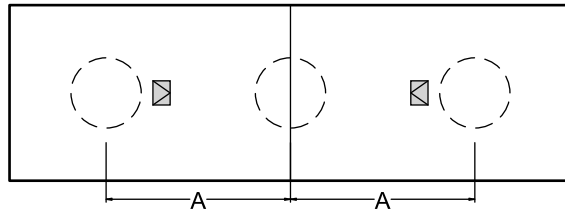

Stone & Vidro
192" x 60"
216" x 60"

A
63"
74"

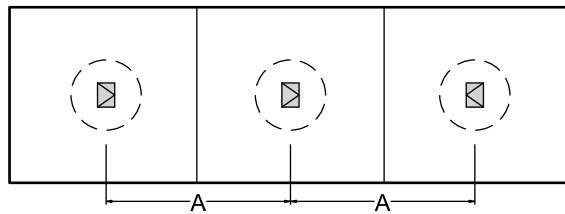
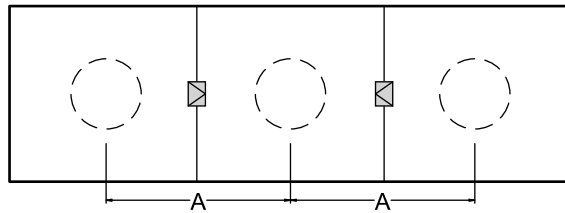

Wood, Stone & Vidro **A**
240" x 60" 86"

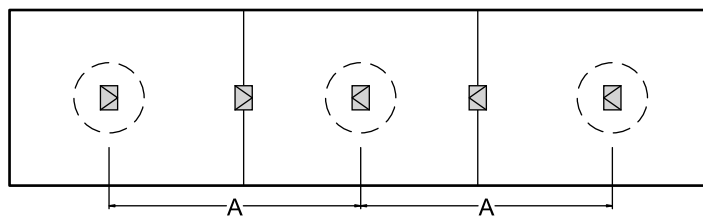
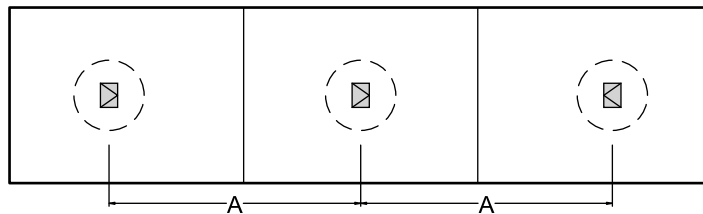

TYPICAL BASE and POWER UNIT LOCATIONS

DRUM BASE • WOOD TOPS

Wood
240" x 72"

A
86"

ARCED BOAT

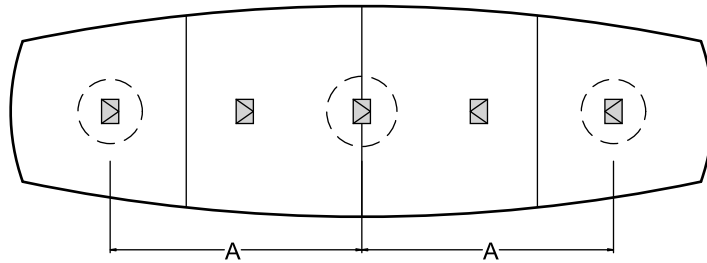
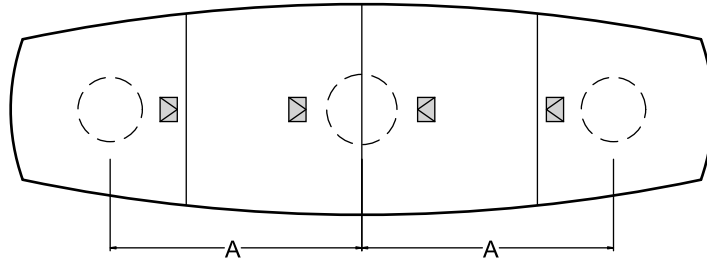
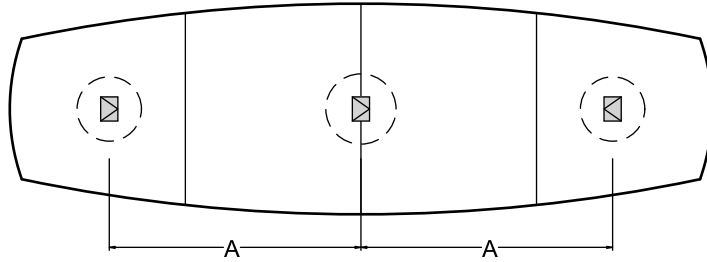

TYPICAL BASE and POWER UNIT LOCATIONS

BLADE & PANEL BASE • WOOD, VIDRO AND STONE TOPS

Wood, Stone & Vidro
All sizes

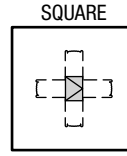
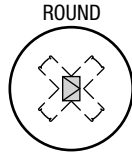

RECTANGLE - ARCED RECTANGLE - ARCED BOAT - ARCED WEDGE

Wood, Stone & Vidro **A**
84" x 42" 38"
96" x 48" 50"

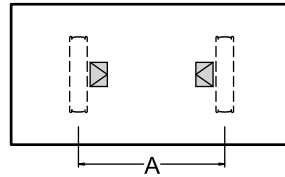
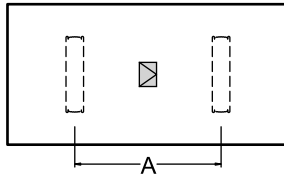

Wood **A**
108" x 48" 62"

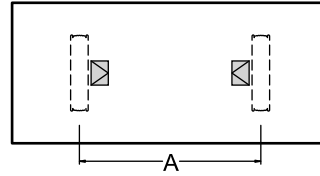
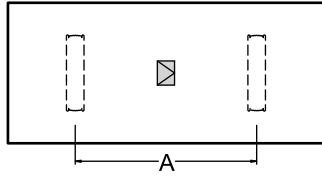

Stone & Vidro **A**
108" x 48" 62"

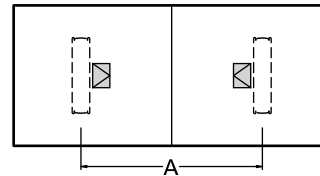
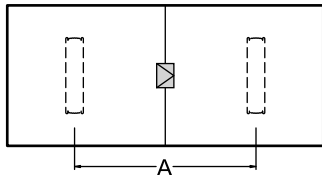

Wood, Stone & Vidro **A**
120" x 48" or 60" 74"
132" x 48" or 60" 86"

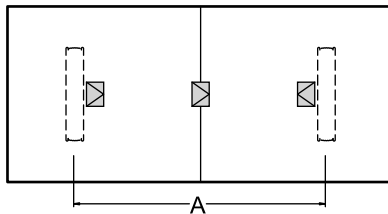
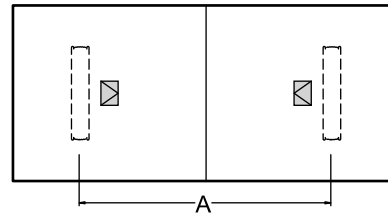
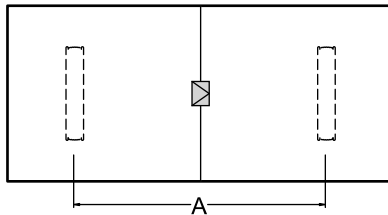

Wood, Stone & Vidro **A**
144" x 48" or 60" 49"
168" x 48" or 60" 61"

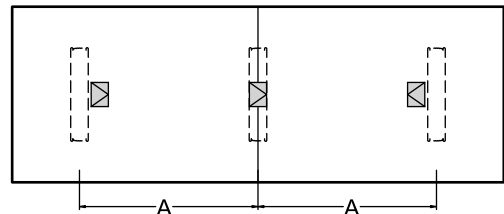
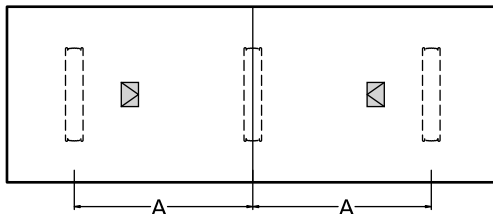

TYPICAL BASE and POWER UNIT LOCATIONS

BLADE & PANEL BASE • WOOD, VIDRO AND STONE TOPS

Wood
192" x 60"

A
70"

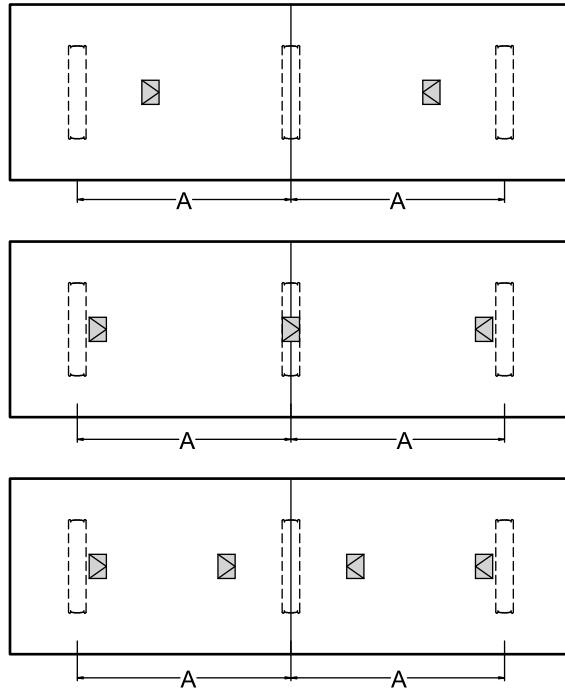

Stone & Vidro
192" x 60"

A
70"

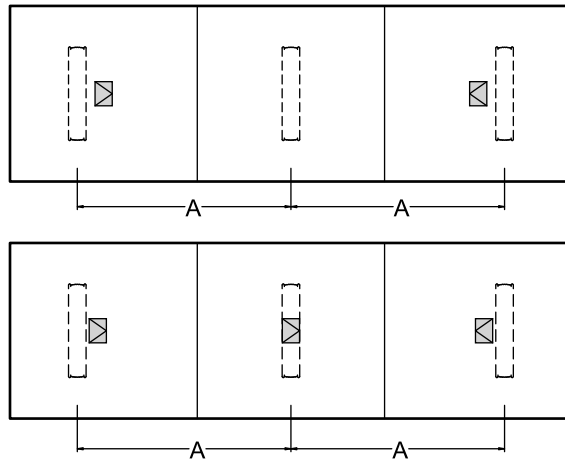

Wood
216" x 60"

A
56"

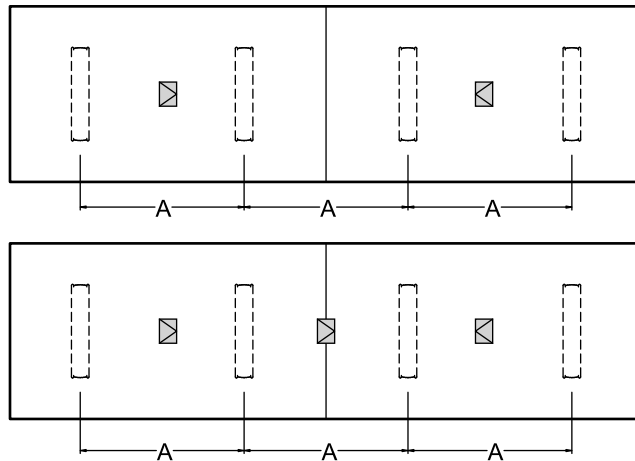

TYPICAL BASE and POWER UNIT LOCATIONS

BLADE & PANEL BASE • WOOD, VIDRO AND STONE TOPS

Wood **A**
 216" x 60" 56"

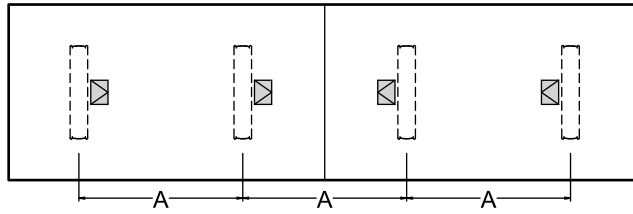

Stone & Vidro **A**
 216" x 60" 56"

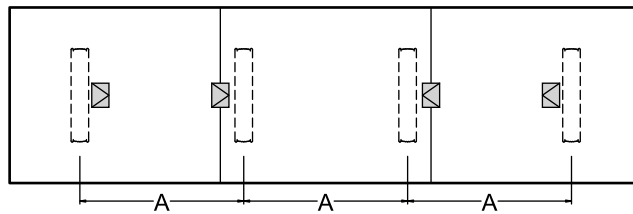
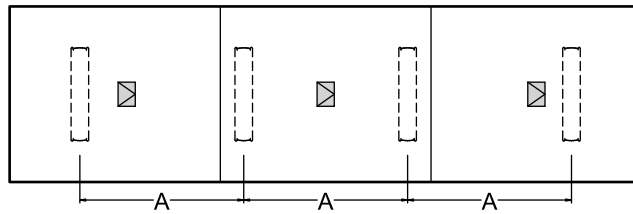
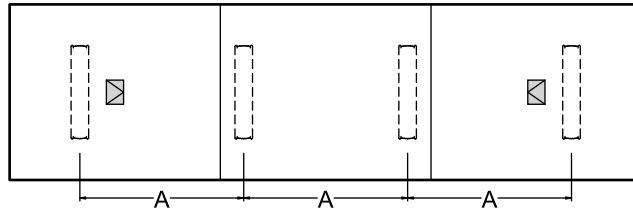

Wood, Stone & Vidro **A**
 240" x 60" 64"

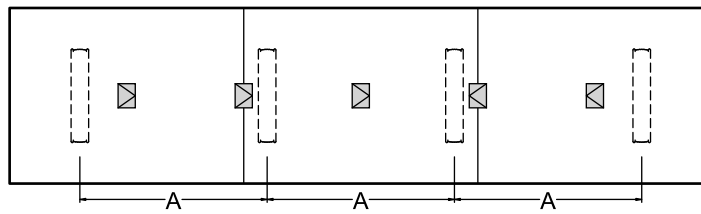
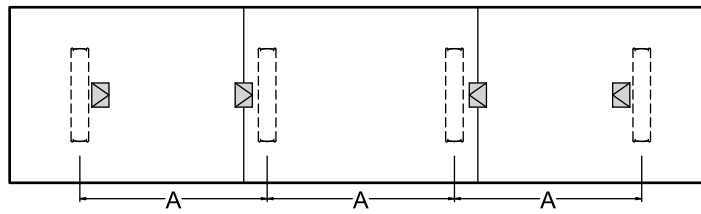
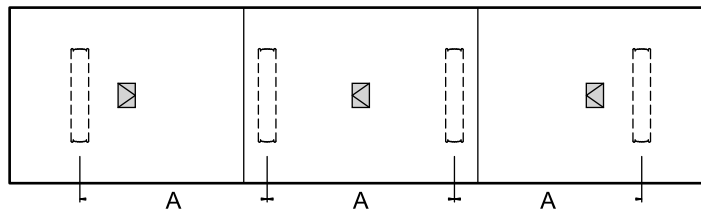

TYPICAL BASE and POWER UNIT LOCATIONS

BLADE & PANEL BASE • WOOD TOPS

ARCED BOAT

Wood
240" x 72"

A
64"

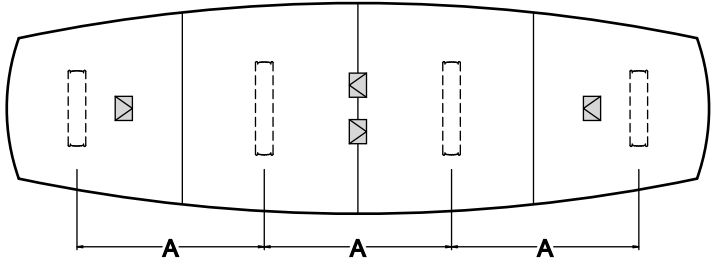
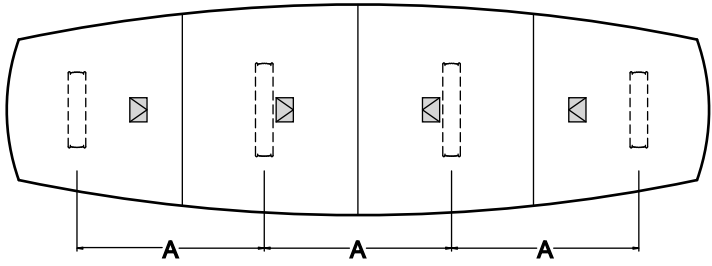
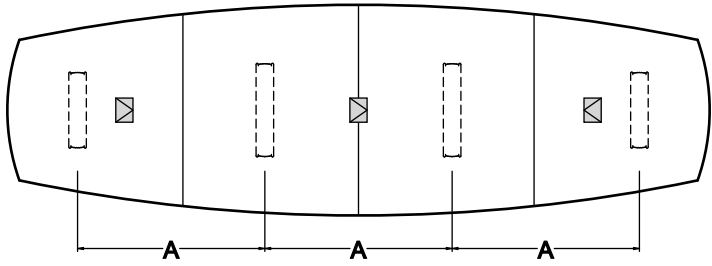

TYPICAL BASE and POWER UNIT LOCATIONS

NEXT T BASE & KONVERSE T BASE • WOOD, VIDRO AND STONE TOPS

RECTANGLE - ARCED RECTANGLE - ARCED BOAT

Wood, Stone & Vidro **A**
 72" x 36" 32"
 84" x 42" 42"
 96" x 48" 50"

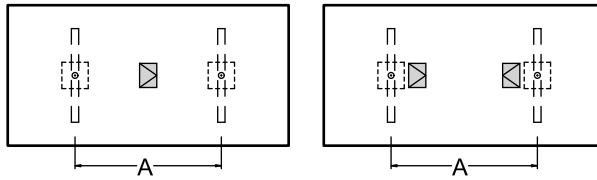

Wood **A**
 108" x 48" 62"

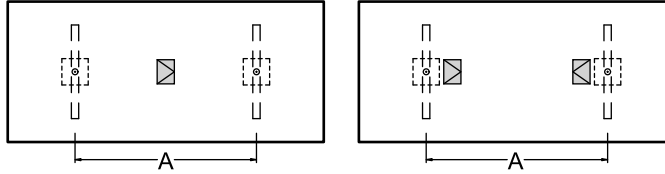

Stone & Vidro **A**
 108" x 48" 31"

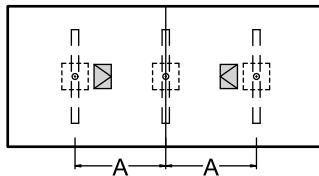

• Center Located Power Unit over T-Base:
 Add \$568.

Wood, Stone & Vidro **A**
 120" x 48" or 60" 37"
 132" x 48" or 60" 43"
 144" x 48" or 60" 49"

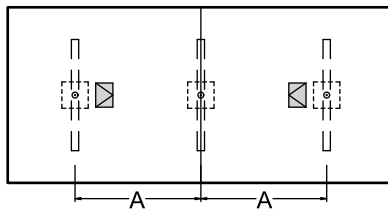

TYPICAL BASE and POWER UNIT LOCATIONS

NEXT T BASE & KONVERSE T BASE • WOOD, VIDRO AND STONE TOPS

Wood, Stone & Vidro **A**
 168" x 60" 40"

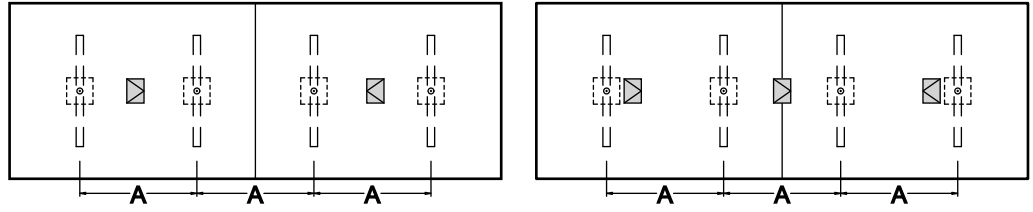

Wood **A**
 192" x 60" 48"

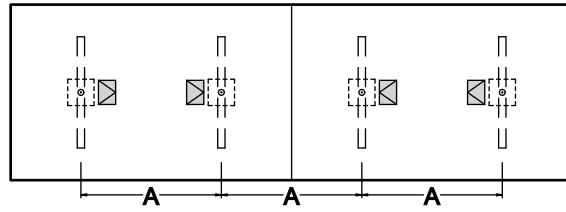
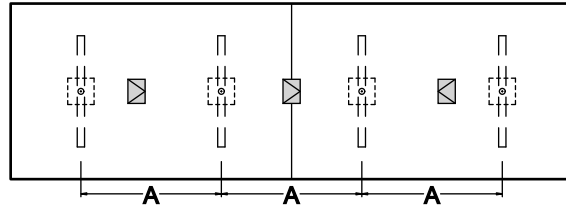
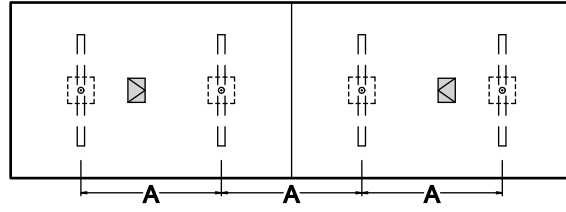

Stone & Vidro **A**
 192" x 60" 48"

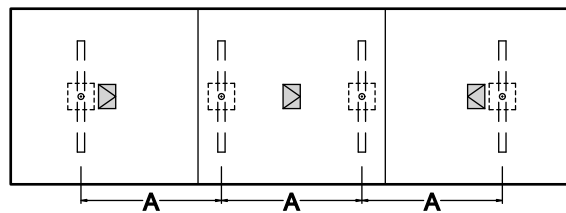
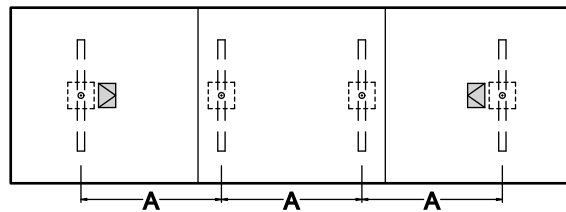

TYPICAL BASE and POWER UNIT LOCATIONS

NEXTT T BASE & KONVERSE T BASE • WOOD, VIDRO AND STONE TOPS

RECTANGLE - ARCED RECTANGLE - ARCED BOAT

Wood
216" x 60"

A
42"

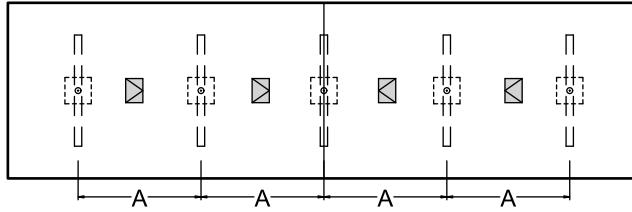
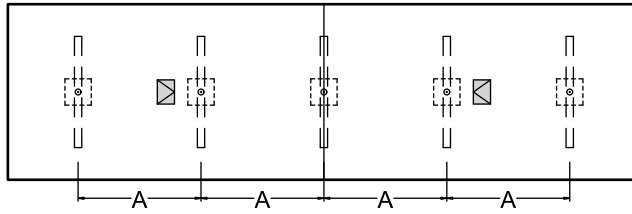

• Center Located Power Unit over T-Base:
Add \$568.

Stone & Vidro
216" x 60"

A
42"

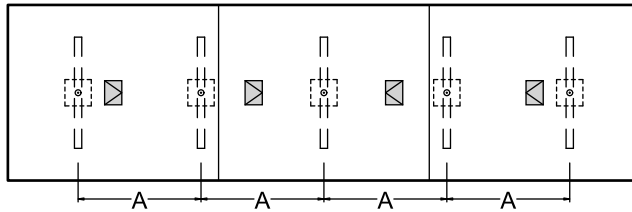
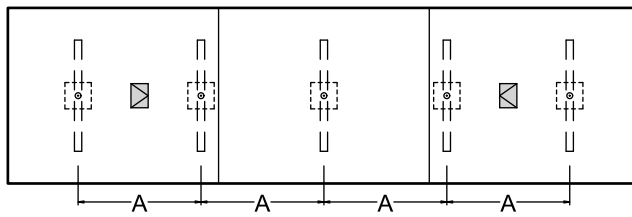

Wood, Stone & Vidro **A**
240" x 60" 48"

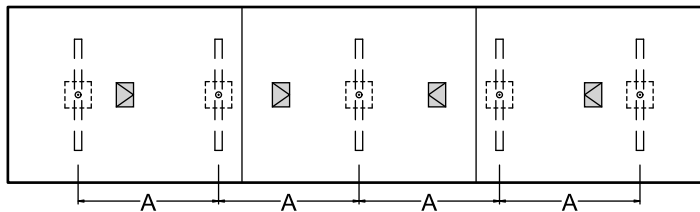
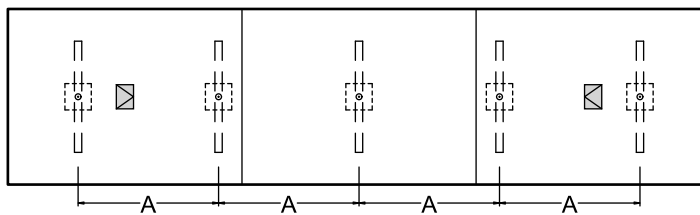

TYPICAL BASE and POWER UNIT LOCATIONS

KABLE T BASE & TUBULAR T BASE & HALF ROUND

4 Column Only
54"
60"

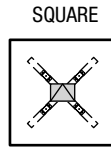
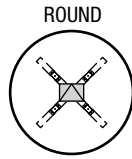

RECTANGLE - BOAT - WEDGE - RACETRACK

Top **A**
72" x 36" or 42" 32"
84" x 42" 42"
96" x 42" or 48" 50"
108" x 48" 62"

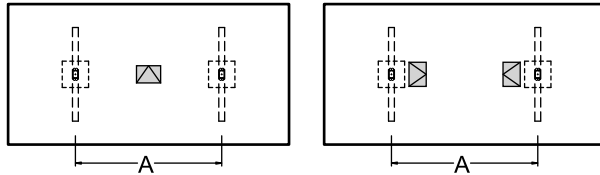

Top **A**
120" x 48" 37"
144" x 48" or 60" 49"

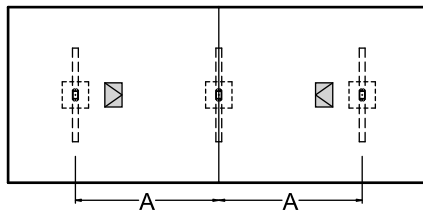

• Center Located Power Unit over T-Base and Cross Base: Add \$568.

Top **A**
168" x 60" 40"
192" x 60" 48"

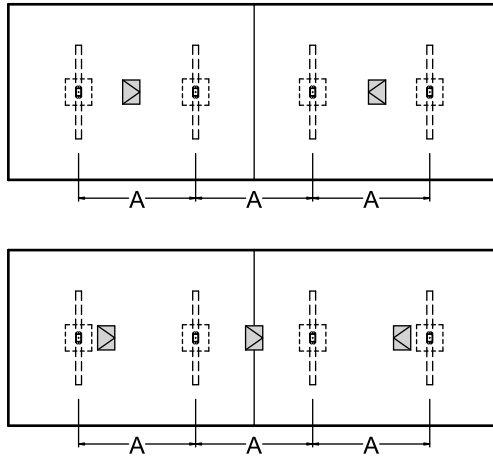

TYPICAL BASE and POWER UNIT LOCATIONS

KABLE T BASE & TUBULAR T BASE & HALF ROUND

RECTANGLE - BOAT - WEDGE - RACETRACK

Top
216" x 60"

A
42"

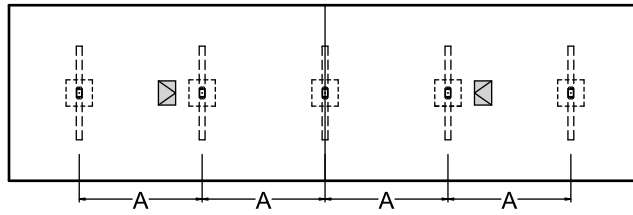

• Center Located Power Unit over T-Base and Cross Base: Add \$568.

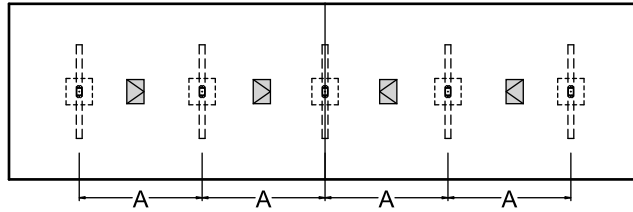

Top
240" x 60"

A
48"

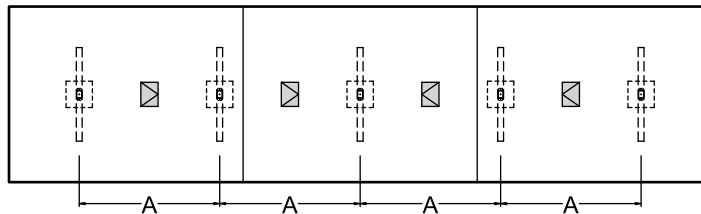
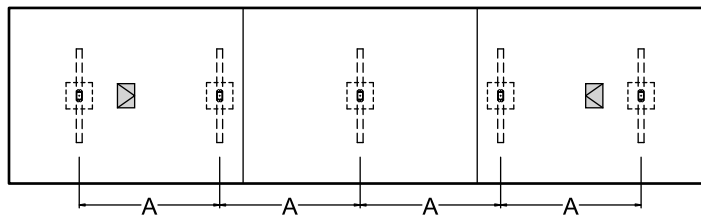

MODULAR

Top
60"
72"
84"
90"

A
24"
32"
42"
44"

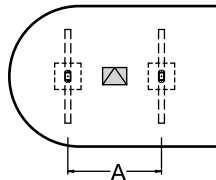
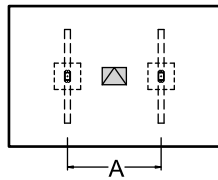

72"
84"
90"

A
32"
42"
44"

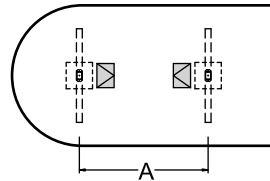
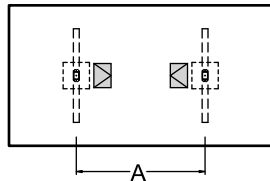

TYPICAL BASE and POWER UNIT LOCATIONS

CUBE BASE • WOOD, VIDRO AND STONE TOPS

Top
42"
48"
54"
60"

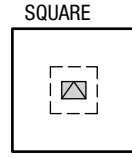
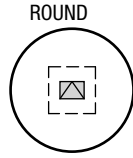

RECTANGLE - BOAT - WEDGE - RACETRACK

Top
84" x 42"
96" x 42" or 48"
108" x 48"

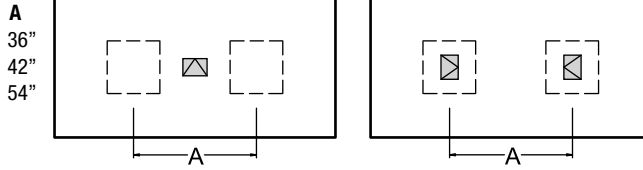

Top
120" x 48"
144" x 48" or 60"

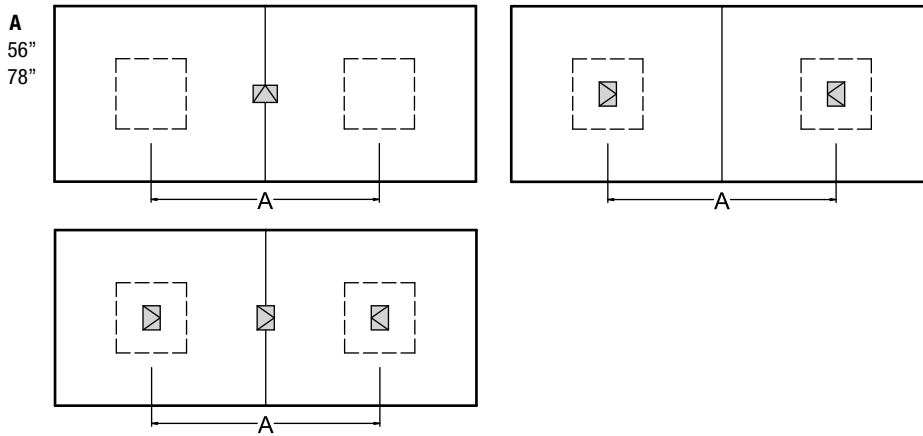

Top
168" x 60"
192" x 60"
216" x 60"

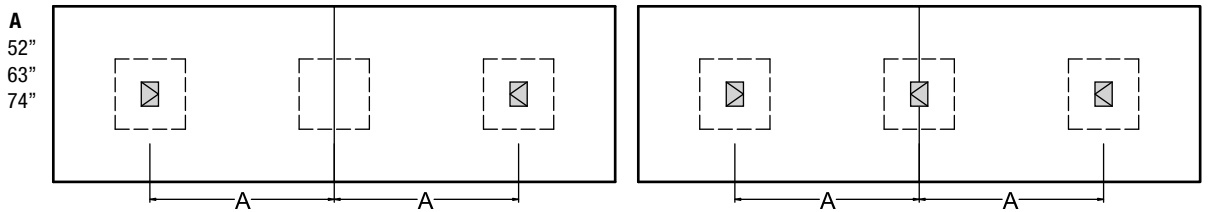

Top
240" x 60"

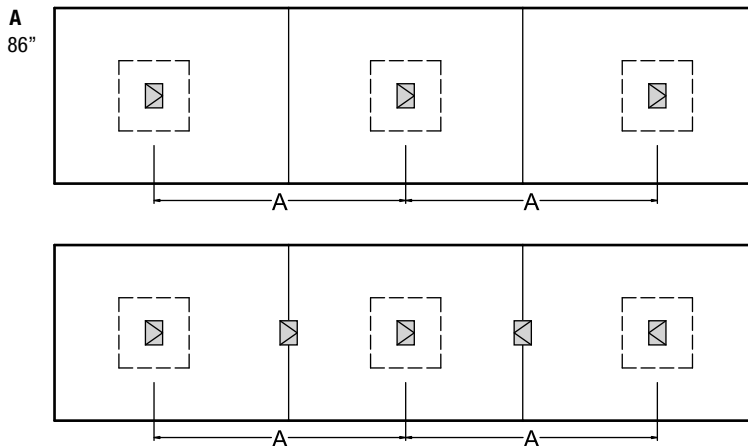

NEXT T and CROSS BASE TABLES • LAMINATE and VENEER TOPS

All table tops, except for veneer with wood edge feature inlays between top surface and edge in matching color to either top or edge unless specified otherwise. Standard Stainless Steel base finish in COLORA colors; Polished and Satin Stainless options upcharged. Tables are 29" high.

Specify: model number – top finish – edge profile and finish – inlay color (if applicable and in contrast color) – base finish – power and comm. options.

ITEM

TOP DIMENSIONS



ROUND

641-42	42" dia.
641-48	48" dia.
641-54	54" dia.
641-60	60" dia.



SQUARE

One-Column

647-42	42" x 42"
647-48	48" x 48"

Four-Column

647-54	54" x 54"
647-60	60" x 60"

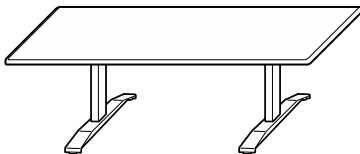

RECTANGLE

645-7236	72" x 36"
645-8442	84" x 42"
645-9648	96" x 48"
645-1084	108" x 48"

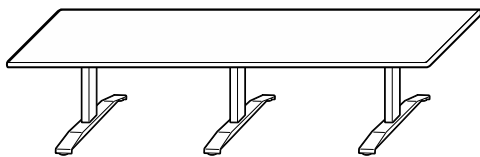

sectioned tops

645-1204	120" x 48"
645-1324	132" x 48"
645-1444	144" x 48"
645-1206	120" x 60"
645-1326	132" x 60"
645-1446	144" x 60"

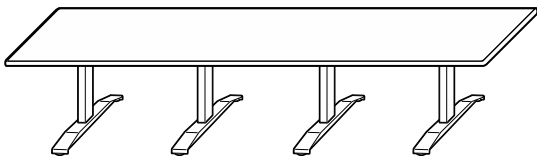

645-1686	168" x 60"
645-1926	192" x 60"

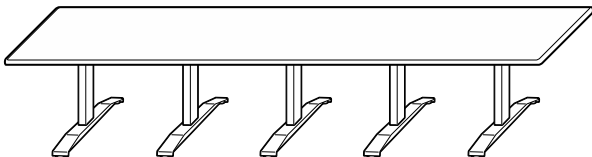

645-2166	216" x 60"
645-2406 (Top in 3 sections)	240" x 60"

- Center Located Power Unit over T-Base or One-Column Cross Base: Add \$568.
- Access Door in One-Column Cross Base: Add \$296.
- All T-Bases include Access Door.

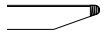
VENEER TOP**ADD BASE UPGRADES**

RB Wood		POL	BRUSH
QTY1	QTY 3	STAIN.	STAIN.

4128	3375	1652	1140
4549	3759	1979	1385
4892	4077	1979	1385
5354	4502	1979	1385
3459	2761	1652	1140
3912	3145	1979	1385
5244	4279	2482	1479
5729	5113	2482	1479
4943	4095	1735	1124
5637	4647	1735	1124
6892	5704	1877	1184
7398	6119	1877	1184
9317	8116	2814	1776
10177	8808	2814	1776
10609	9205	2814	1776
10780	9309	3544	2260
11407	9849	3544	2260
11860	10296	3544	2260
14358	12480	4725	3012
15729	13647	4725	3012
18480	16084	5905	3766
20410	17798	5905	3766

NEXTT T and CROSS BASE TABLES • LAMINATE and VENEER TOPS

All table tops, except for veneer with wood edge feature inlays between top surface and edge in matching color to either top or edge unless specified otherwise. Standard Stainless Steel base finish in COLORA colors; Polished and Satin Stainless options upcharged. Tables are 29" high.

Specify: model number – top finish – edge profile and finish – inlay color (if applicable and in contrast color) – base finish – power and comm. options.

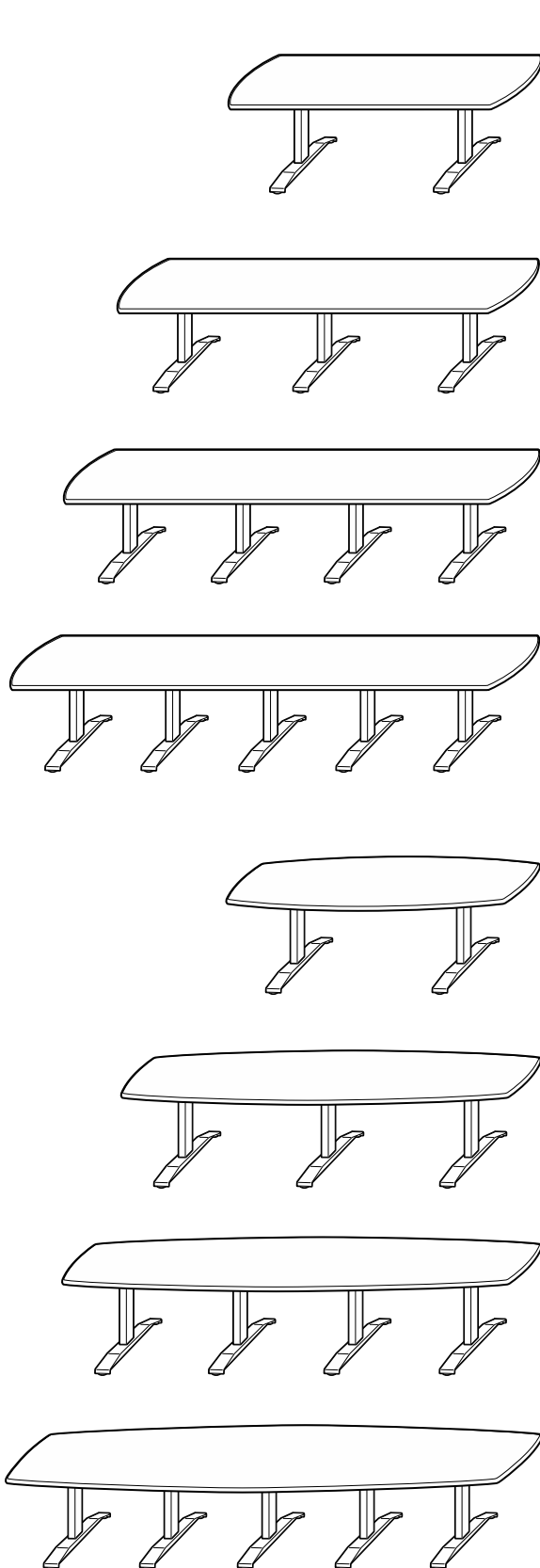

ITEM

TOP DIMENSIONS

ARCED RECTANGLE

648-7236	72" x 36"
648-8442	84" x 42"
648-9648	96" x 48"
648-1084	108" x 48"

sectioned tops

648-1204	120" x 48"
648-1324	132" x 48"
648-1444	144" x 48"
648-1206	120" x 60"
648-1326	132" x 60"
648-1446	144" x 60"
648-1686	168" x 60"
648-1926	192" x 60"

648-2166	216" x 60"
648-2406 (Top in 3 sections)	240" x 60"

ARCED BOAT

646-7236	72" x 36"/25"
646-8442	84" x 42"/30"
646-9648	96" x 48"/35"
646-1084	108" x 48"/35"

sectioned tops

646-1204	120" x 48"/35"
646-1324	132" x 48"/35"
646-1206	120" x 60"/42"
646-1326	132" x 60"/42"
646-1446	144" x 60"/42"

646-1686	168" x 60"/42"
646-1926	192" x 60"/42"

646-2166	216" x 60"/42"
646-2406 (Top in 3 sections)	240" x 60"/42"

- Center Located Power Unit over T-Base: Add \$568.
- All T-Bases include Access Door.

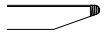
veneER TOP**ADD BASE UPGRADES**

RB Wood		POL	BRUSH
QTY1	QTY 3	STAIN.	STAIN.

5604	4749	1735	1124
6367	5317	1735	1124
7702	6396	1877	1184
8260	6806	1877	1184

10783	8630	2814	1776
11260	9184	2814	1776
11739	9739	2814	1776
11887	9798	3544	2260
12622	10416	3544	2260
13070	10848	3544	2260

15289	12888	4725	3012
16725	13877	4725	3012

19762	17003	5905	3766
21827	18828	5905	3766

5604	4749	1735	1124
6367	5317	1735	1124
7702	6396	1877	1184
8260	6806	1877	1184

10783	8630	2814	1776
11260	9184	2814	1776
11739	9739	2814	1776
11887	9798	3544	2260
12622	10416	3544	2260
13495	11093	3544	2260

15785	13176	4725	3012
17294	14203	4725	3012

19762	17003	5905	3766
21827	18828	5905	3766

NEXT T and CROSS BASE TABLES • VIDRO PAINTED BACK GLASS TOP

See standard color choices. Customer's own color must be pre-approved through custom quotation.
Bases standard Stainless Steel in COLORA, Polished and Brushed Stainless options upcharged. Tables are 29" high.



ITEM

TOP DIMENSIONS

ROUND

641V-30	30" dia.
641V-36	36" dia.
641V-42	42" dia.
641V-48	48" dia.
641V-54	54" dia.
641V-60	60" dia.



SQUARE

One-Column

642V-42	42" x 42"
642V-48	48" x 48"

Four-Column

642V-54	54" x 54"
642V-60	60" x 60"

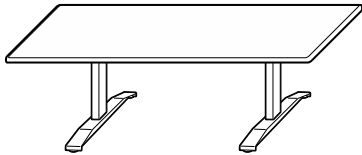

RECTANGLE

645V-7236	72" x 36"
645V-8442	84" x 42"
645V-9648	96" x 48"
645V-1084 (Top in 2 sections)	108" x 48"

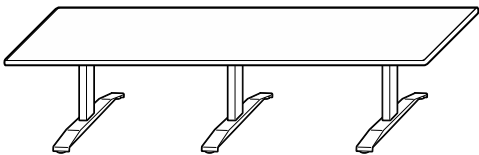

sectioned tops

645V-1204	120" x 48"
645V-1324	132" x 48"
645V-1444	144" x 48"
645V-1206	120" x 60" (includes double column bases)
645V-1326	132" x 60" (includes double column bases)
645V-1446	144" x 60" (includes double column bases)

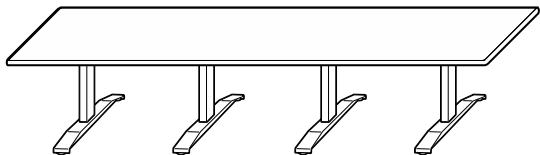

645V-1686	168" x 60" (includes double column bases)
645V-1926 (Top in 3 sections)	192" x 60" (includes double column bases)

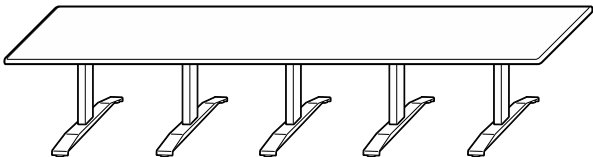

645V-2166 (Top in 3 sections)	216" x 60" (includes double column bases)
645V-2406 (Top in 4 sections)	240" x 60" (includes double column bases)

- Center Located Power Unit over T-Base or One-Column Cross Base: Add \$568.
- Access Door in One-Column Cross Base: Add \$296.
- All T-Bases include Access Door.

PAINTED BACK GLASS TOP (CL GLASS)

MATTE (MA GLASS)

ADD BASE UPGRADES

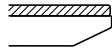

1 1/4" RB

QTY1 QTY3

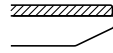

1 1/4" RB

QTY1 QTY3

ADD
CRATE
NET \$

POL.
STAIN

BRUSH
STAIN

2744	2486	3208	2926	95	1652	1140
3145	2888	3767	3485	114	1652	1140
3919	3649	4760	4466	134	1652	1140
4836	4425	5942	5481	153	1979	1385
5514	5101	6872	6410	172	1979	1385
6351	5928	7990	7518	191	1979	1385
4185	3823	5076	4664	134	1652	1140
4739	4371	5938	5411	153	1979	1385
6368	5940	7727	7249	172	2482	1479
7110	6680	8749	8269	191	2482	1479
6402	5979	7713	7241	208	1735	1124
7538	7103	9222	8739	243	1735	1124
8902	8448	11015	10513	277	1877	1184
9651	9191	12004	11495	312	1877	1184
12609	11547	15444	14237	347	2814	1776
13340	12261	16392	15166	382	2814	1776
14204	13111	17493	16256	416	2814	1776
14270	13178	17643	16407	382	3544	2260
15393	14277	19085	17824	420	3544	2260
16526	15400	20536	19265	458	3544	2260
19106	17894	23655	22299	535	4725	3012
22165	20941	27546	26175	611	4725	3012
25539	24205	31555	30076	686	5905	3766
27035	25696	33614	32129	762	5905	3766

NEXT T and CROSS

• Vidro Art option require additional details - custom quote required.

NEXT T and CROSS BASE TABLES • VIDRO PAINTED BACK GLASS TOP

See standard color choices. Customer's own color must be pre-approved through custom quotation.
Bases standard Stainless Steel in COLORA, Polished and Brushed Stainless options upcharged. Tables are 29" high.

ITEM

TOP DIMENSIONS

ARCED RECTANGLE

648V-7236	72" x 36"
648V-8442	84" x 42"
648V-9648	96" x 48"
648V-1084 (Top in 2 sections)	108" x 48"

sectioned tops

648V-1204	120" x 48"
648V-1324	132" x 48"
648V-1444	144" x 48"
648V-1206	120" x 60" (includes double column bases)
648V-1326	132" x 60" (includes double column bases)
648V-1446	144" x 60" (includes double column bases)

648V-1686	168" x 60" (includes double column bases)
648V-1926 (Top in 3 sections)	192" x 60" (includes double column bases)

648V-2166 (Top in 3 sections)	216" x 60" (includes double column bases)
648V-2406 (Top in 4 sections)	240" x 60" (includes double column bases)

ARCED BOAT

646V-7236	72" x 36"/25"
646V-8442	84" x 42"/30"
646V-9648	96" x 48"/35"
646V-1084 (Top in 2 sections)	108" x 48"/35"

sectioned tops

646V-1204	120" x 48"/35"
646V-1324	132" x 48"/35"
646V-1444	144" x 48"/35"
646V-1206	120" x 60"/42" (includes double column bases)
646V-1326	132" x 60"/42" (includes double column bases)
646V-1446	144" x 60"/42" (includes double column bases)

646V-1686	168" x 60"/42" (includes double column bases)
646V-1926 (Top in 3 sections)	192" x 60"/42" (includes double column bases)

646V-2166 (Top in 3 sections)	216" x 60"/42" (includes double column bases)
646V-2406 (Top in 4 sections)	240" x 60"/42" (includes double column bases)

- Center Located Power Unit over T-Base: Add \$568.
- All T-Bases include Access Door.

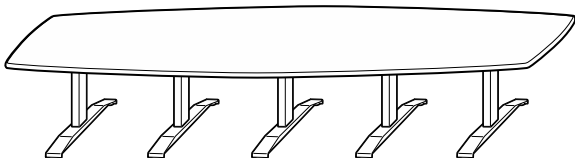
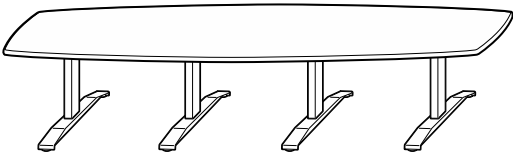
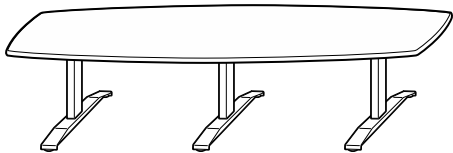
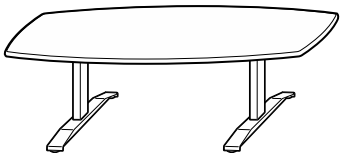
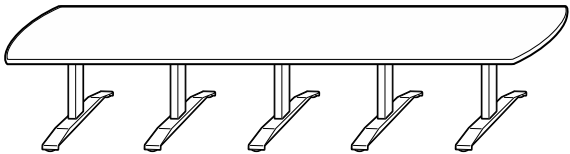
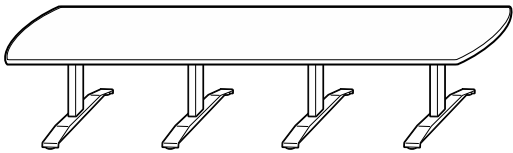
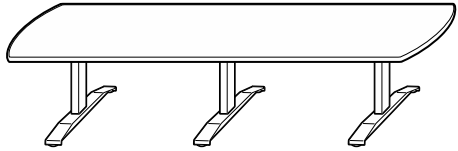
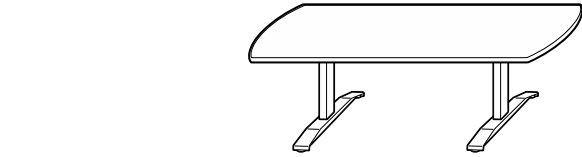

PAINTED BACK GLASS TOP (CL GLASS)

MATTE (MA GLASS)

ADD BASE UPGRADES

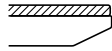

1 1/4" RB

QTY1 QTY3

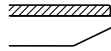

1 1/4" RB

QTY1 QTY3

ADD
CRATE
NET \$

POL.
STAIN

BRUSH
STAIN

6950	6528	8351	7881	208	1735	1124
8285	7850	10093	9609	243	1735	1124
9876	9422	12151	11647	277	1877	1184
10749	10288	13283	12774	312	1877	1184
13827	12765	16865	15656	347	2814	1776
14680	13602	17954	16729	382	2814	1776
15667	14573	19199	17960	416	2814	1776
15792	14703	19418	18183	382	3544	2260
17069	15965	21039	19788	420	3544	2260
18347	17228	23199	21934	458	3544	2260
21239	20026	26141	24782	535	4725	3012
24603	23378	30386	29014	611	4725	3012
27748	26415	34217	32739	686	5905	3766
29948	28608	37031	35545	762	5905	3766
6950	6528	8351	7881	208	1735	1124
8285	7850	10093	9609	243	1735	1124
9876	9422	12151	11647	277	1877	1184
10749	10288	13283	12774	312	1877	1184
13827	12765	16865	15656	347	2814	1776
14680	13602	17954	16729	382	2814	1776
15667	14573	19199	17960	416	2814	1776
15792	14703	19418	18183	382	3544	2260
17069	15965	21039	19788	420	3544	2260
18347	17228	22660	21394	458	3544	2260
21239	20026	26141	24782	535	4725	3012
24603	23378	30386	29014	611	4725	3012
28281	26947	34751	33271	686	5905	3766
30082	28742	37165	35679	762	5905	3766

NEXT T and CROSS

• Vidro Art option requires additional details - custom quote required.

NEXT T and CROSS BASE TABLES • VIDRO PAINTED BACK GLASS TOP

See standard color choices. Customer's own color must be pre-approved through custom quotation.
 Bases standard Stainless Steel in COLORA, Polished and Brushed Stainless options upcharged. Tables are 29" high.

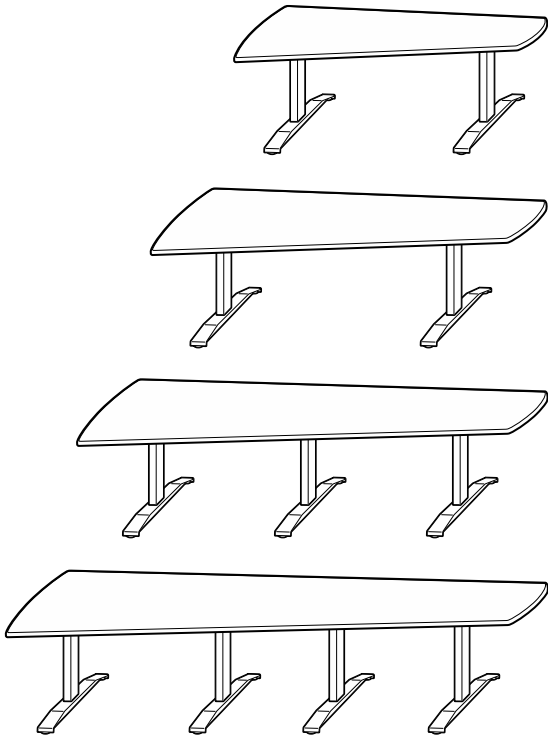

ITEM

TOP DIMENSIONS

ARCED WEDGE

629V-8448	84" x 48"/28"
629V-9648	96" x 48"/28"
629V-1084 (Top in 2 sections)	108" x 48"/28"

Sectioned tops

629V-1206	120" x 60"/35"	(includes double column bases)
629V-1326	132" x 60"/35"	(includes double column bases)

629V-1446	144" x 60"/35"	(includes double column bases)
629V-1686	168" x 60"/35"	(includes double column bases)
629V-1926 (Top in 3 sections)	192" x 60"/35"	(includes double column bases)

629V-2166 (Top in 3 sections)	216" x 60"/35"	(includes double column bases)
629V-2406 (Top in 4 sections)	240" x 60"/35"	(includes double column bases)

- Center Located Power Unit over T-Base: Add \$568.
- All T-Bases include Access Door.

PAINTED BACK GLASS TOP (CL GLASS)

MATTE (MA GLASS)

ADD BASE UPGRADES

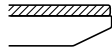

1 1/4" RB

QTY1 QTY3

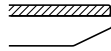

1 1/4" RB

QTY1 QTY3

**ADD
CRATE
NET \$**

**POL.
STAIN**

**BRUSH
STAIN**

8839	8404	10853	10370	243	1735	1124
9876	9422	12151	11647	277	1877	1184
10749	10288	13283	12774	312	1877	1184
15792	14703	19418	18183	382	3544	2260
17069	15965	21039	19788	420	3544	2260
18347	17228	22660	21394	458	3544	2260
21239	20026	26141	24782	535	4725	3012
24603	23378	30386	29014	611	4725	3012
28281	26947	34751	33271	686	5905	3766
30082	28742	37165	35679	762	5905	3766

NEXT T and CROSS

• Vidro Art option requires additional details - custom quote required.

NEXT T and CROSS BASE TABLES • STONE TOP

See selection of top and base finishes. Standard Stainless Steel base finish in COLORA colors; Polished and Satin Stainless options upcharged.

Tables are 29" high. Crate charges apply to stone tops.

Note: 60" wide marble tops are subject to availability – please inquire.

Specify: model number – stone top variety – edge profile – base finish – power and comm. options.

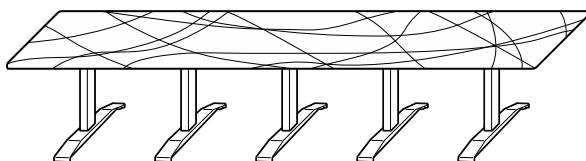
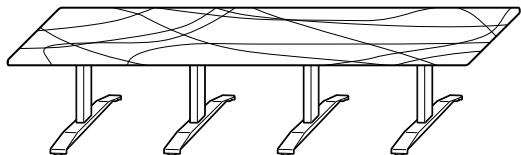
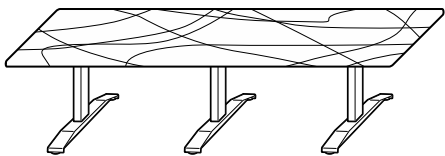
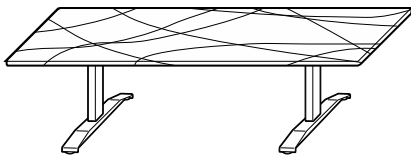
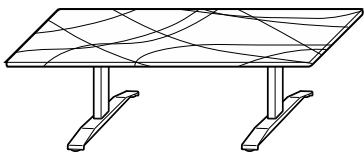
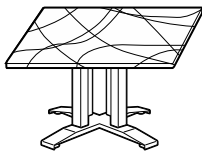
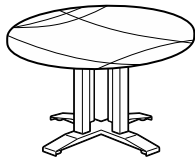

ITEM

TOP DIMENSIONS

ROUND

One-Column

641M-42 42" dia.

641M-48 48" dia.

Four-Column

641M-54 54" dia.

641M-60 60" dia.

SQUARE

One-Column

647M-42 42" x 42"

647M-48 48" x 48"

Four-Column

647M-54 54" x 54"

647M-60 60" x 60"

RECTANGLE

645M-7236 72" x 36"

645M-8442 84" x 42"

645M-9648 96" x 48"

sectioned tops

645M-1084 108" x 48"

645M-1204 120" x 48"

645M-1324 132" x 48"

645M-1444 144" x 48"

645M-1206 120" x 60" (includes double column bases)

645M-1326 132" x 60" (includes double column bases)

645M-1446 144" x 60" (includes double column bases)

645M-1686 168" x 60" (includes double column bases)

645M-1926 (Top in 3 sections) 192" x 60" (includes double column bases)

645M-2166 216" x 60" (includes double column bases)

645M-2406 240" x 60" (includes double column bases)

- Number of sectioned tops may vary based on type of stone.
- Center Located Power Unit over T-Base or One-Column Cross Base: Add \$568.
- Access Door in One-Column Cross Base: Add \$296.
- All T-Bases include Access Door.

MARBLE or GRANITE TOP

ADD BASE UPGRADES

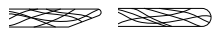

3/4" RB or 3/4" BN

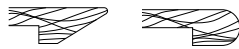

1 1/2" RB or 1 1/2" BN

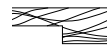

1 1/2" SQ

**ADD
CRATE
NET \$**

**POL
STAIN.**

**BRUSH
STAIN.**

7870	9469	8509	134	1652	1140
9665	11493	10397	153	1979	1385
11528	13587	12352	172	2482	1479
13639	15924	14552	191	2482	1479
7785	8654	7820	134	1652	1140
9510	10504	9552	153	1979	1385
12175	13293	12223	172	2482	1479
14099	15339	14152	191	2482	1479
11675	12722	11675	208	1735	1124
14417	15639	14417	243	1735	1124
17555	18952	17555	277	1877	1184
21344	22857	21344	312	1877	1184
23769	25398	23769	347	2814	1776
25434	27179	25434	382	2814	1776
27098	28961	27098	416	2814	1776
28311	30058	28311	382	3544	2260
30252	32113	30252	420	3544	2260
32190	34170	32190	458	3544	2260
38044	40311	38044	535	4725	3012
44640	47206	44640	611	4725	3012
51270	54150	51270	686	5905	3766
56113	59312	56113	762	5905	3766

NEXT T and CROSS

NEXT T and CROSS BASE TABLES • STONE TOP

See selection of top and base finishes. Standard Stainless Steel base finish in COLORA colors; Polished and Satin Stainless options upcharged.

Tables are 29" high. Crate charges apply to stone tops.

Note: 60" wide marble tops are subject to availability – please inquire.

Specify: model number – stone top variety – edge profile – base finish – power and comm. options.

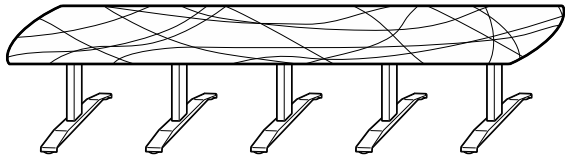
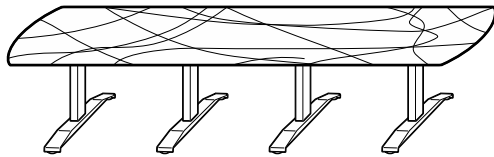
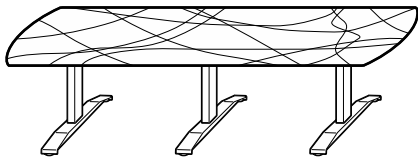
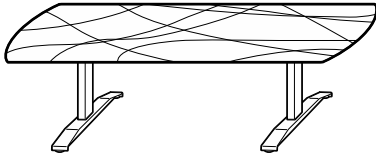
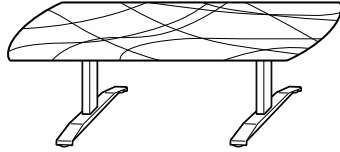

ITEM

TOP DIMENSIONS

ARCED RECTANGLE

648M-7236	72" x 36"
648M-8442	84" x 42"

648M-9648	96" x 48"
-----------	-----------

sectioned tops

648M-1084	108" x 48"
648M-1204	120" x 48"
648M-1324	132" x 48"
648M-1444	144" x 48"
648M-1206	120" x 60" (includes double column bases)
648M-1326	132" x 60" (includes double column bases)
648M-1446	144" x 60" (includes double column bases)

648M-1686	168" x 60" (includes double column bases)
648M-1926 (Top in 3 sections)	192" x 60" (includes double column bases)

648M-2166	216" x 60" (includes double column bases)
648M-2406	240" x 60" (includes double column bases)

- Number of sectioned tops may vary based on type of stone.
- Center Located Power Unit over T-Base: Add \$568.
- All T-Bases include Access Door.

MARBLE or GRANITE TOP

ADD BASE UPGRADES

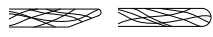

3/4" RB or 3/4" BN

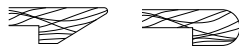

1 1/2" RB or 1 1/2" BN

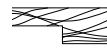

1 1/2" SQ

**ADD
CRATE
NET \$**

**POL
STAIN.**

**BRUSH
STAIN.**

12333	13903	12681	208	1735	1124
15277	17110	15684	243	1735	1124
18643	20740	19110	277	1877	1184
22541	24753	23007	312	1877	1184
25073	27400	25538	347	2814	1776
26845	29288	27310	382	2814	1776
28617	31177	29082	416	2814	1776
29941	32560	30523	382	3544	2260
32014	34749	32598	420	3544	2260
34088	36940	34669	458	3544	2260
40263	43426	40860	535	4725	3012
47321	50806	47933	611	4725	3012
54174	57991	54799	686	5905	3766
59376	63538	60018	762	5905	3766

NEXT T and CROSS

NEXT T and CROSS BASE TABLES • STONE TOP

See selection of top and base finishes. Standard Stainless Steel base finish in COLORA colors; Polished and Satin Stainless options upcharged.

Tables are 29" high. Crate charges apply to stone tops.

Note: 60" wide marble tops are subject to availability – please inquire.

Specify: model number – stone top variety – edge profile – base finish – power and comm. options.

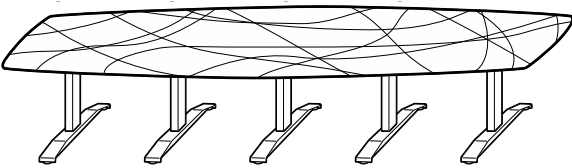
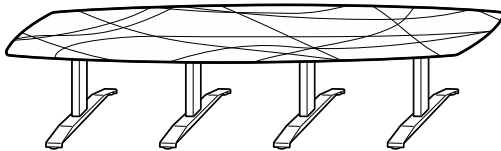
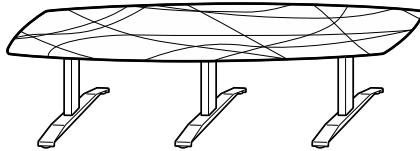
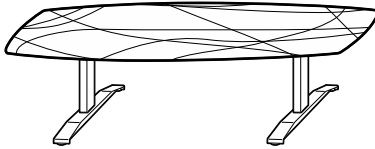
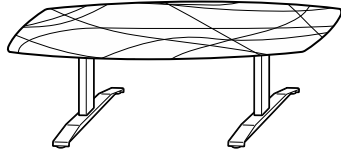

ITEM

TOP DIMENSIONS

ARCED BOAT

646M-7236	72" x 36"/25"
646M-8442	84" x 42"/30"

646M-9648	96" x 48"/35"
-----------	---------------

sectioned tops

646M-1084	108" x 48"/35"
646M-1204	120" x 48"/35"
646M-1324	132" x 48"/35"
646M-1444	144" x 48"/35"
646M-1206	120" x 60"/42" (includes double column bases)
646M-1326	132" x 60"/42" (includes double column bases)
646M-1446	144" x 60"/42" (includes double column bases)

646M-1686	168" x 60"/42" (includes double column bases)
646M-1926 (Top in 3 sections)	192" x 60"/42" (includes double column bases)

646M-2166	216" x 60"/42" (includes double column bases)
646M-2406	240" x 60"/42" (includes double column bases)

- Number of sectioned tops may vary based on type of stone.
- Center Located Power Unit over T-Base: Add \$568.
- All T-Bases include Access Door.

MARBLE or GRANITE TOP

ADD BASE UPGRADES

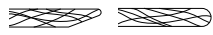

3/4" RB or 3/4" BN

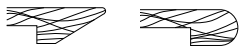

1 1/2" RB or 1 1/2" BN

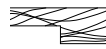

1 1/2" SQ

**ADD
CRATE
NET \$**

**POL
STAIN.**

**BRUSH
STAIN.**

12681	15300	13727	208	1735	1735
15684	18740	16905	243	1735	1735
19110	22603	20507	277	1877	1877
20287	24070	21799	312	1877	1877
25655	29730	27285	347	2814	2814
27485	31851	29231	382	2814	2814
29314	33971	31177	416	2814	2814
30523	34890	32270	382	3544	3544
32655	37312	34517	420	3544	3544
34787	39732	36766	458	3544	3544
41099	46766	43365	535	4725	4725
48299	54717	50866	611	4725	4725
55301	62496	58179	686	5905	5905
60657	68660	63858	762	5905	5905

NEXT T and CROSS

NEXTT C BASE TRAINING TABLES • LAMINATE and VENEER TOPS

Laminate tops with wood or COLORA edge feature 1/8" dia. vinyl inlay in COLORA between top surface and edge. Standard base finish is COLORA colors; polished and satin chrome are available at upcharge. Modesty panels are in COLORA colors. Tables are 29" high.

Specify: model number – top finish – edge profile and finish – inlay color (if applicable) – base finish – modesty finish – options.

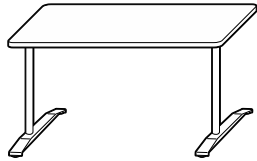

ITEM

DIMENSIONS

WITHOUT MODESTY PANEL

633-4220	42" x 20"	
633-4820	48" x 20"	
633-6020	60" x 20"	
633-7220	72" x 20"	C-Bases located 6" from end of table
633-4224	42" x 24"	(non-folding only)
633-4824	48" x 24"	
633-6024	60" x 24"	
633-7224	72" x 24"	
633-4830	48" x 30"	
633-6030	60" x 30"	
633-7230	72" x 30"	

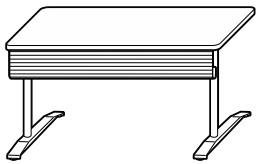

WITH J MODESTY PANEL (REMOVABLE)

Extruded aluminum modesty panel in ribbed pattern features a large wire management tray. 7 1/2" high. Removable (without tools) for folding base tables.

635-4220	42" x 20"	
635-4820	48" x 20"	
635-6020	60" x 20"	
635-7220	72" x 20"	C-Bases located 6" from end of table
635-4224	42" x 24"	(non-folding only)
635-4824	48" x 24"	
635-6024	60" x 24"	
635-7224	72" x 24"	
635-4830	48" x 30"	
635-6030	60" x 30"	
635-7230	72" x 30"	

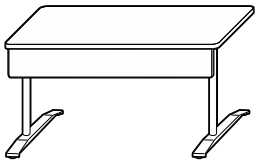

WITH FLAT FIXED MODESTY

Flat aluminum modesty panel fixed to table top, 9" high.

637-4220	42" x 20"	
637-4820	48" x 20"	
637-6020	60" x 20"	
637-7220	72" x 20"	C-Bases located 6" from end of table
637-4224	42" x 24"	(non-folding only)
637-4824	48" x 24"	
637-6024	60" x 24"	
637-7224	72" x 24"	
637-4830	48" x 30"	
637-6030	60" x 30"	
637-7230	72" x 30"	

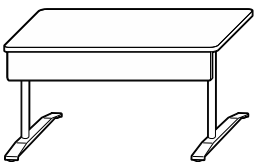

WITH FLAT FOLDING MODESTY

Utilized with Folding Base or Flip Top options - add costs. Flat aluminum modesty panel is 9" high and folds over bases in folded position or over table underside with flip top option.

639-6024	60" x 24"	C-Bases located 6" from end of table
639-7224	72" x 24"	(non-folding only)
639-6030	60" x 30"	
639-7230	72" x 30"	

BRIDGE TOP - Connector plates included

90-deg PIE

996-20	20" R x 20"
996-24	24" R x 24"
996-30	30" R x 30"

45-deg PIE

997-20	20" R x 20"
997-24	24" R x 24"
997-30	30" R x 30"

30-deg PIE

998-20	20" R x 20"
998-24	24" R x 24"
998-30	30" R x 30"

GANG SET

Each set \$96.00 factory installed. Consists of two brackets, a linking bar and two thumb screws. Ganging 24", 30" and 36" sides requires 1 set; 42" sides and over requires 2 sets.



PLASTIC LAMINATE TOP

VENEER TOP



Flat Vinyl



Reeded Wood



Square Wood

QTY1	Flat Vinyl		Reeded Wood			Square Wood			ADD FOLDING BASE*	ADD FLIP TOP	ADD BRUSH STAIN	ADD POL STAIN
	QTY3	QTY10	QTY1	QTY3	QTY10	QTY1	QTY3	QTY10				
1995	1831	1655	2910	2478	2160	2879	2414	2165		569	482	1157
2009	1843	1666	2955	2518	2194	2941	2475	2227		569	482	1157
2156	1973	1786	3173	2738	2370	3132	2647	2394	471	569	482	1157
2259	2063	1868	3348	2858	2507	3331	2814	2561	471	569	482	1157
2030	1864	1686	2961	2524	2204	2970	2505	2257		569	489	1170
2050	1881	1702	3019	2573	2250	3047	2581	2332		569	489	1170
2185	2000	1811	3225	2754	2412	3263	2774	2521	471	569	489	1170
2286	2090	1894	3399	2908	2550	3482	2965	2709	471	569	489	1170
2194	2010	1823	3194	2731	2396	3278	2789	2536		569	493	1185
2303	2107	1911	3374	2890	2539	3548	3028	2767	471	569	493	1185
2430	2219	2015	3574	3065	2695	3838	3262	2997	471	569	493	1185
2524	2228	2023	3439	2875	2528	3408	2811	2534			482	1157
2538	2240	2034	3484	2915	2562	3470	2873	2595			482	1157
2690	2409	2193	3706	3175	2777	3666	3084	2801	471		482	1157
2832	2541	2317	3921	3337	2956	3904	3293	3010	471		482	1157
2559	2261	2054	3490	2921	2572	3500	2902	2625		569	489	1170
2579	2279	2071	3548	2970	2618	3577	2978	2701		569	489	1170
2719	2437	2218	3758	3190	2819	3797	3210	2928	471	569	489	1170
2859	2569	2342	3973	3386	2999	4055	3443	3157	471	569	489	1170
2723	2407	2192	3723	3128	2765	3808	3186	2904		569	493	1185
2836	2544	2318	3908	3327	2946	4081	3464	3174	471	569	493	1185
3003	2698	2463	4147	3544	3144	4411	3740	3556	471	569	493	1185
2303	2103	1900	3218	2749	2405	3187	2686	2411			482	1157
2317	2115	1911	3263	2790	2439	3249	2747	2472			482	1157
2480	2258	2044	3496	3023	2628	3456	2932	2653			482	1157
2653	2418	2198	3742	3214	2837	3725	3170	2891			482	1157
2338	2136	1931	3269	2796	2449	3278	2777	2502		569	489	1170
2358	2153	1947	3327	2845	2495	3355	2853	2578		569	489	1170
2508	2285	2070	3548	3039	2670	3586	3058	2779		569	489	1170
2680	2446	2224	3793	3263	2880	3876	3320	3039		569	489	1170
2502	2282	2068	3502	3002	2642	3586	3061	2781		569	493	1185
2626	2392	2170	3698	3175	2798	3871	3313	3025		569	493	1185
2824	2574	2345	3968	3420	3025	4232	3617	3327		569	493	1185
2824	2577	2359	3864	3330	2959	3902	3350	3068	471	569	489	1170
3038	2727	2472	4151	3545	3129	4233	3602	3287	471	569	489	1170
2942	2683	2459	4013	3467	3087	4187	3604	3315	471	569	493	1185
3182	2856	2593	4326	3702	3274	4590	3899	3575	471	569	493	1185
473	445	426	1052	895	790	912	805	744				
498	466	445	1075	917	813	984	877	813				
543	505	480	1137	978	871	1041	935	871				
449	421	402	1028	871	767	834	725	664				
473	443	421	1052	895	790	902	796	733				
520	481	459	1114	955	849	939	831	770				
440	410	390	1015	858	756	785	678	614				
461	429	407	1038	882	777	795	686	624				
504	469	445	1098	941	832	805	697	635				

NEXT C - TRAINING

- Self Edge Laminate available at same price as Vinyl Edge.
- Low Rise Casters: \$176.00 per C Base. Always recommended for Flip Top tables.
- *• 60" long folding tables have narrow range of suitable Surface Power Units based on location(s) and quantity - please inquire

NEXTT T BASE TABLES • MODULAR • LAMINATE and VENEER TOPS

Laminate tops with wood or COLORA edge feature 1/8" dia. vinyl inlay in COLORA between top surface and edge. Standard base finish is COLORA colors; polished and satin chrome are available at upcharge. Tables are 29" high.

Specify: model number – top finish – edge profile and finish – inlay color (if applicable) – base finish – options.

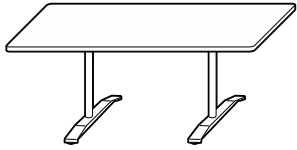

ITEM

DIMENSIONS

RECTANGLE

632-4220	42" x 20"	
632-4820	48" x 20"	
632-6020	60" x 20"	
632-7220	72" x 20"	T-Bases located 12" from end of table (non-folding only)
632-4224	42" x 24"	
632-4824	48" x 24"	
632-6024	60" x 24"	
632-7224	72" x 24"	
632-4830	48" x 30"	
632-6030	60" x 30"	
632-7230	72" x 30"	

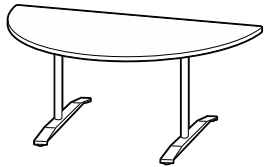

HALF ROUND

634-4820	48" dia. x 20"
634-4824	48" dia. x 24"
634-5427	54" dia. x 27"
634-6030	60" dia. x 30"

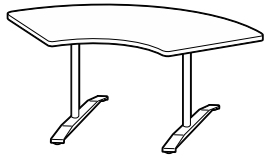

ARC

636-3620	36" R x 20"
636-3624	36" R x 24"
636-4824	48" R x 24"
636-4830	48" R x 30"
636-6024	60" R x 24"
636-6030	60" R x 30"

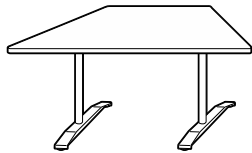

TRAPEZOID

638-4824	48" X 24" X 24"
638-6030	60" X 30" X 30"
638-7230	72" X 30" X 30"

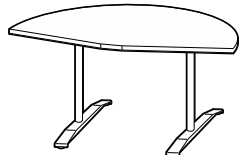

V END

170-deg PIE

640-24 (for 24" D Tables)	54" x 30"
640-30 (for 30" D Tables)	66" x 36"

PLASTIC LAMINATE TOP

VENEER TOP



Flat Vinyl



Reeded Wood



Reeded Wood

QTY1	Flat Vinyl		Reeded Wood			Square Wood			ADD FOLDING BASE*	ADD FLIP TOP	ADD BRUSH STAIN	ADD POL STAIN
	QTY3	QTY10	QTY1	QTY3	QTY10	QTY1	QTY3	QTY10				
1995	1831	1655	2910	2478	2160	2879	2414	2165		569	482	1157
2009	1843	1666	2955	2518	2194	2941	2475	2227		569	482	1157
2156	1973	1786	3173	2738	2370	3132	2647	2394	471	569	482	1157
2259	2063	1868	3348	2858	2507	3331	2814	2561	471	569	482	1157
2030	1864	1686	2961	2524	2204	2970	2505	2257		569	489	1170
2050	1881	1702	3019	2573	2250	3047	2581	2332		569	489	1170
2185	2000	1811	3225	2754	2412	3263	2774	2521	471	569	489	1170
2286	2090	1894	3399	2908	2550	3482	2965	2709	471	569	489	1170
2194	2010	1823	3194	2731	2396	3278	2789	2536		569	493	1185
2303	2107	1911	3374	2890	2539	3548	3028	2767	471	569	493	1185
2430	2219	2015	3574	3065	2695	3838	3262	2997	471	569	493	1185
2273	2079	1885	3385	2906	2551	3456	2903	2563		569	482	1157
2303	2107	1912	3445	2962	2605	3573	3021	2681		569	489	1170
2477	2262	2054	3656	3154	2778	3754	3194	2849		569	489	1170
2680	2445	2225	3896	3373	2977	4031	3454	3096		569	493	1185
2253	2062	1869	3751	3233	2879	3688	3182	2843		569	482	1157
2309	2114	1918	3811	3288	2931	3711	3206	2866		569	489	1170
2418	2452	2230	4285	3696	3300	4389	3793	3438		569	489	1170
2867	2612	2379	4454	3849	3441	4503	3875	3507		569	493	1185
2946	2679	2439	4688	4035	3604	5217	4525	4150		655	489	1170
2826	2576	2346	4591	3954	3533	5246	4554	4179		655	493	1185
2182	2000	1813	3134	2677	2345	3087	2613	2357		569	489	1170
2532	2314	2104	3556	3050	2684	3588	3058	2790		569	493	1185
2867	2612	2379	3937	3384	2986	4009	3376	3100		569	493	1185
2510	2292	2082	4151	3563	3176	3977	3393	3025		569	493	1185
2867	2612	2379	4602	3947	3523	4420	3801	3414		579	493	1185

NEXT T - MODULAR

- Self Edge Laminate available at same price as Vinyl Edge.
- Low Rise Casters: \$176.00 per T Base. Always recommended for Flip Top tables.
- *• 60" long folding tables have narrow range of suitable Surface Power Units based on location(s) and quantity - please inquire

KONVERSE T and CROSS BASE TABLES • LAMINATE and VENEER TOPS

All table tops, except for veneer with wood edge feature inlays between top surface and edge in matching color to either top or edge unless specified otherwise. Standard base finish is COLORA colors; chrome base upcharges are shown below. Tables are 29" high.

Specify: model number – top finish – edge profile and finish – inlay color (if applicable and in contrast color) – base finish – power and comm. options.



ITEM

TOP DIMENSIONS

ROUND

841-42	42" dia.
841-48	48" dia.
841-54	54" dia.
841-60	60" dia.



SQUARE

847-42	42" x 42"
847-48	48" x 48"
847-54	54" x 54"
847-60	60" x 60"

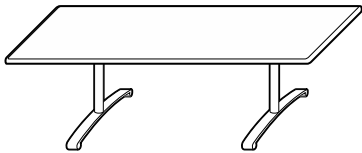

RECTANGLE

845-7236	72" x 36"
845-8442	84" x 42"
845-9648	96" x 48"
845-1084	108" x 48"

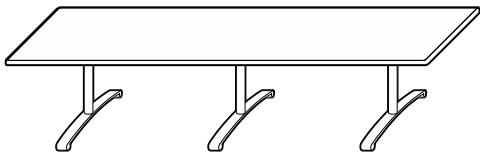

sectioned tops

845-1204	120" x 48"
845-1324	132" x 48"
845-1444	144" x 48"
845-1206	120" x 60"
845-1326	132" x 60"
845-1446	144" x 60"

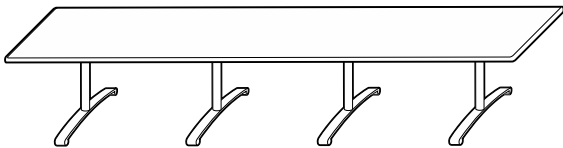

845-1686	168" x 60"
845-1926	192" x 60"

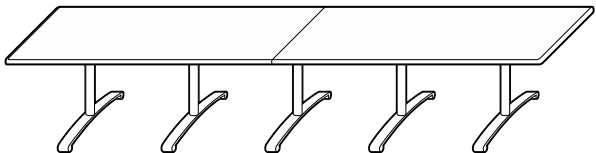

845-2166	216" x 60"
845-2406 (Top in 3 sections)	240" x 60"

• Center Located Power Unit over T-Base and Cross Base: Add \$568.

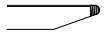
VENEER TOP**ADD BASE UPGRADES**
RB Wood
QTY1
QTY 3
SATIN +
POL
CHROME

4774	4032	597
5122	4353	597
5565	4768	664
5959	5137	664

4121	3432	597
4573	3825	597
5054	4198	664
5568	5057	664

5113	4276	407
6292	5084	407
7653	6512	509
8188	6960	509

10520	9302	763
11400	10031	763
11862	10474	763
11768	10315	912
12428	10895	912
12916	11383	912

15778	13969	1216
17209	15213	1216

20221	17929	1521
22116	19620	1521

KONVERSE T and CROSS BASE TABLES • LAMINATE and VENEER TOPS

All table tops, except for veneer with wood edge feature inlays between top surface and edge in matching color to either top or edge unless specified otherwise. Standard base finish is COLORA colors; chrome base upcharges are shown below. Tables are 29" high.

Specify: model number – top finish – edge profile and finish – inlay color (if applicable and in contrast color) – base finish – power and comm. options.

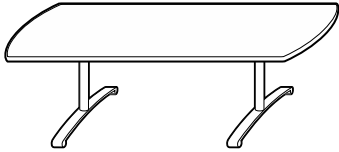

ITEM

TOP DIMENSIONS

ARCED RECTANGLE

848-7236	72" x 36"
848-8442	84" x 42"
848-9648	96" x 48"
848-1084	108" x 48"

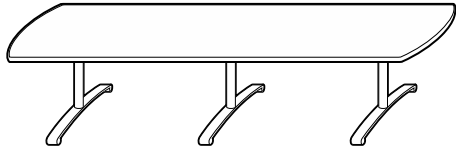

sectioned tops

848-1204	120" x 48"
848-1324	132" x 48"
848-1444	144" x 48"
848-1206	120" x 60"
848-1326	132" x 60"
848-1446	144" x 60"

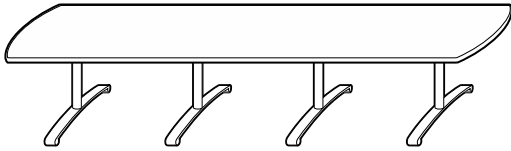

848-1686	168" x 60"
848-1926	192" x 60"

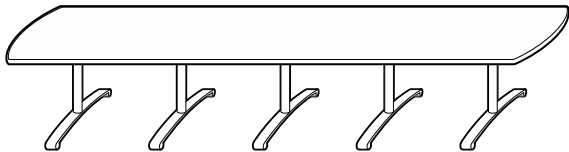

848-2166	216" x 60"
848-2406 (Top in 3 sections)	240" x 60"

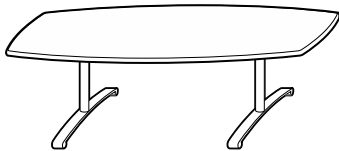

ARCED BOAT

846-7236	72" x 36"/25"
846-8442	84" x 42"/30"
846-9648	96" x 48"/35"
846-1084	108" x 48"/35"

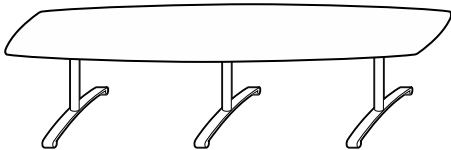

sectioned tops

846-1204	120" x 48"/35"
846-1324	132" x 48"/35"
846-1444	144" x 48"/35"
846-1206	120" x 60"/42"
846-1326	132" x 60"/42"
846-1446	144" x 60"/42"

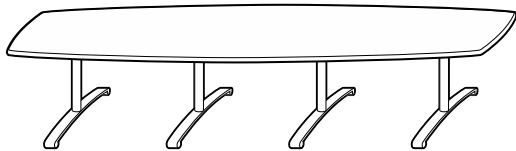

846-1686	168" x 60"/42"
846-1926	192" x 60"/42"

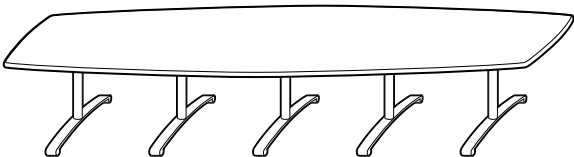

846-2166	216" x 60"/42"
846-2406 (Top in 3 sections)	240" x 60"/42"

• Center Located Power Unit over T-Base: Add \$568.

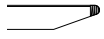
veneer top **add base upgrades****RB Wood
QTY1****QTY 3****SATIN +
POL
CHROME**

5764	4921	407
7013	5745	407
8454	7196	509
9037	7638	509

11965	9808	763
12469	10403	763
12975	11002	763
12861	10799	912
13626	11454	912
14109	11928	912

16697	14373	1216
18194	15438	1216

21483	18836	1521
23514	20636	1521

5764	4921	407
7013	5745	407
8398	7143	509
8982	7524	509

11965	9808	763
12469	10403	763
12975	11002	763
12861	10799	912
13626	11454	912
14527	12169	912

17186	14801	1216
18752	15760	1216

21483	18836	1521
23514	20636	1521

KONVERSE T and CROSS BASE TABLES • VIDRO PAINTED BACK GLASS TOP

See standard color choices. Customer's own color must be pre-approved through custom quotation.
Bases standard in COLORA, Polished and Satin Chrome options upcharged. Tables are 29" high.



ITEM

TOP DIMENSIONS

ROUND

841V-42	42" dia.
841V-48	48" dia.
841V-54	54" dia.
841V-60	60" dia.



SQUARE

847V-42	42" x 42"
847V-48	48" x 48"
847V-54	54" x 54"
847V-60	60" x 60"

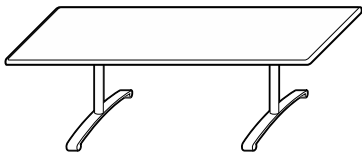

RECTANGLE

845V-7236	72" x 36"
845V-8442	84" x 42"
845V-9648	96" x 48"
845V-1084 (Top in 2 sections)	108" x 48"

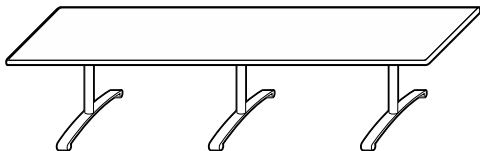

sectioned tops

845V-1204	120" x 48"
845V-1324	132" x 48"
845V-1444	144" x 48"
845V-1206	120" x 60" (includes double column bases)
845V-1326	132" x 60" (includes double column bases)
845V-1446	144" x 60" (includes double column bases)

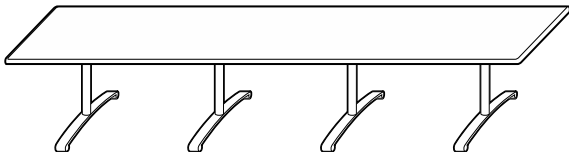

845V-1686	168" x 60" (includes double column bases)
845V-1926 (Top in 3 sections)	192" x 60" (includes double column bases)

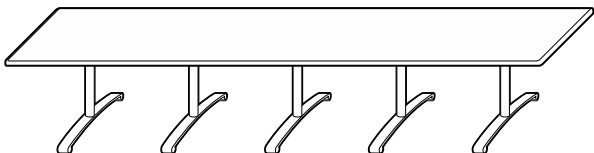

845V-2166 (Top in 3 sections)	216" x 60" (includes double column bases)
845V-2406 (Top in 4 sections)	240" x 60" (includes double column bases)

• Center Located Power Unit over T-Base and Cross Base: Add \$568.

PAINTED BACK GLASS TOP (CL GLASS)

MATTE (MA GLASS)

ADD BASE UPGRADES

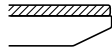

1 1/4" RB

QTY1 QTY3

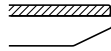

1 1/4" RB

QTY1 QTY3

ADD
CRATE
NET \$

SATIN +
POL CHROME

4375	4156	5217	4974	134	597
5196	4844	6301	5900	153	597
6188	5819	7546	7128	172	664
7418	7025	9057	8615	191	664
4642	4329	5533	5170	134	597
5100	4791	6189	5832	153	597
6188	5822	7546	7131	172	664
7417	7033	9056	8622	191	664
6439	6064	7749	7325	208	407
7857	7461	9541	9096	232	407
9420	9001	11533	11065	277	509
10120	9698	12473	12003	312	509
13554	12532	16389	15221	347	763
14283	13250	17334	16155	382	763
15149	14104	18440	17248	416	763
14941	13914	18314	17143	382	912
16066	15028	19759	18574	420	912
17195	16144	21205	20008	458	912
20084	18958	24633	23362	535	1216
23142	22008	28522	27242	611	1216
26716	25498	32732	31369	686	1521
28129	26911	34708	33344	762	1521

• Vidro Art option require additional details - custom quote required.

KONVERSE T and CROSS BASE TABLES • VIDRO PAINTED BACK GLASS TOP

See standard color choices. Customer's own color must be pre-approved through custom quotation.
Bases standard in COLORA, Polished and Satin Chrome options upcharged. Tables are 29" high.

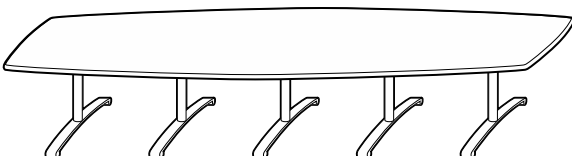
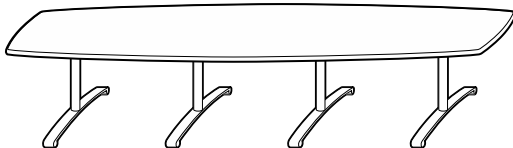
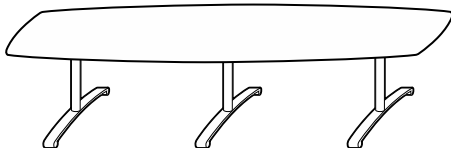
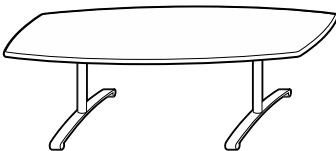
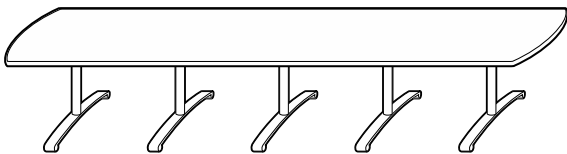
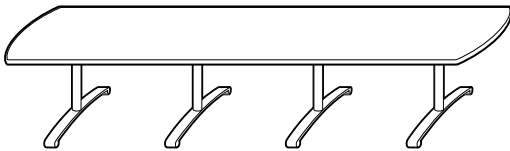
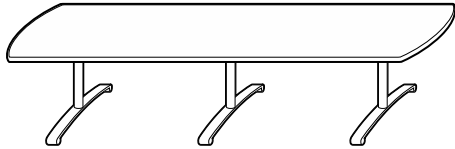
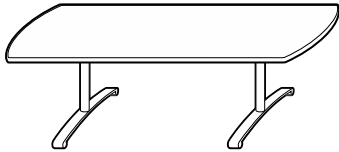

ITEM

TOP DIMENSIONS

ARCED RECTANGLE

848V-7236	72" x 36"
848V-8442	84" x 42"
848V-9648	96" x 48"
848V-1084 (Top in 2 sections)	108" x 48"

sectioned tops

848V-1204	120" x 48"
848V-1324	132" x 48"
848V-1444	144" x 48"
848V-1206	120" x 60" (includes double column bases)
848V-1326	132" x 60" (includes double column bases)
848V-1446	144" x 60" (includes double column bases)

848V-1686	168" x 60" (includes double column bases)
848V-1926 (Top in 3 sections)	192" x 60" (includes double column bases)

848V-2166 (Top in 3 sections)	216" x 60" (includes double column bases)
848V-2406 (Top in 4 sections)	240" x 60" (includes double column bases)

ARCED BOAT

846V-7236	72" x 36"/25"
846V-8442	84" x 42"/30"
846V-9648	96" x 48"/35"
846V-1084 (Top in 2 sections)	108" x 48"/35"

sectioned tops

846V-1204	120" x 48"/35"
846V-1324	132" x 48"/35"
846V-1444	144" x 48"/35"
846V-1206	120" x 60"/42" (includes double column bases)
846V-1326	132" x 60"/42" (includes double column bases)
846V-1446	144" x 60"/42" (includes double column bases)

846V-1686	168" x 60"/42" (includes double column bases)
846V-1926 (Top in 3 sections)	192" x 60"/42" (includes double column bases)

846V-2166 (Top in 3 sections)	216" x 60"/42" (includes double column bases)
846V-2406 (Top in 4 sections)	240" x 60"/42" (includes double column bases)

• Center Located Power Unit over T-Base: Add \$568.

PAINTED BACK GLASS TOP (CL GLASS)

MATTE (MA GLASS)

ADD BASE UPGRADES

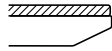

1 1/4" RB

QTY1 QTY3

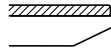

1 1/4" RB

QTY1 QTY3

ADD
CRATE
NET \$

SATIN +
POL CHROME

6989	6611	8389	7964	208	407
8604	8208	10412	9966	243	407
10395	9975	12670	12201	277	509
11216	10796	13750	13282	312	509
14773	13749	17811	16640	347	763
15625	14590	18898	17717	382	763
16610	15565	20143	18952	416	763
16465	15438	20091	18918	382	912
17742	16703	21712	20526	420	912
19022	17972	23874	22679	458	912
22216	21091	27118	25847	535	1216
25580	24446	31363	30082	611	1216
28926	27707	35395	34031	686	1521
31044	29826	38126	36762	762	1521
6989	6611	8389	7964	208	407
8604	8208	10412	9966	243	407
10395	9975	12670	12201	277	509
11244	10820	13778	13306	312	509
14773	13749	17811	16640	347	763
15625	14590	18898	17717	382	763
16610	15565	20143	18952	416	763
16465	15438	20091	18918	382	912
17742	16703	21712	20526	420	912
19022	17972	23335	22139	458	912
22216	21091	27118	25847	535	1216
25580	24446	31363	30082	611	1216
29458	28241	35928	34565	686	1521
31176	29958	38258	36894	762	1521

• Vidro Art option require additional details - custom quote required.

KONVERSE T and CROSS BASE TABLES • STONE TOP

See selection of top and base finishes. Standard base finish is COLORA colors; chrome base upcharges are shown below.

Tables are 29" high. Crate charges apply to stone tops.

Note: 60" wide marble tops are subject to availability – please inquire.

Specify: model number – stone top variety – edge profile – base finish – power and comm. options.

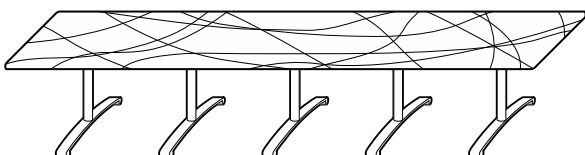
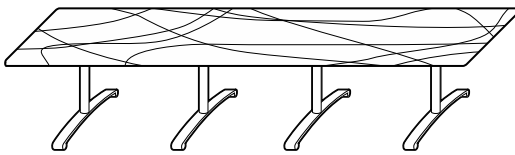
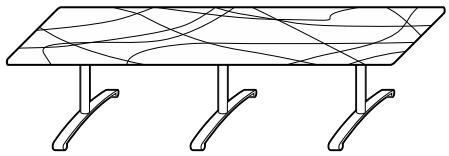
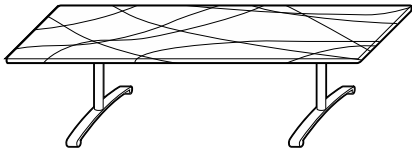
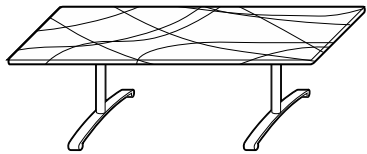
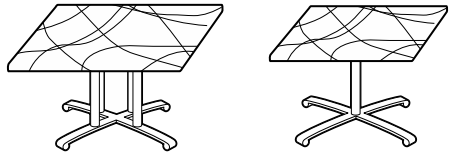
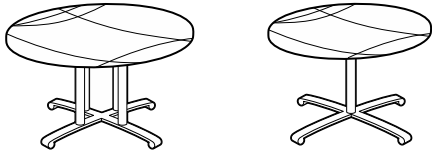

ITEM

TOP DIMENSIONS

ROUND

One-Column

841M-42 42" dia.

841M-48 48" dia.

Four-Column

841M-54 54" dia.

841M-60 60" dia.

SQUARE

One-Column

847M-42 42" x 42"

847M-48 48" x 48"

Four-Column

847M-54 54" x 54"

847M-60 60" x 60"

RECTANGLE

845M-7236 72" x 36"

845M-8442 84" x 42"

845M-9648 96" x 48"

sectioned tops

845M-1084 108" x 48"

845M-1204 120" x 48"

845M-1324 132" x 48"

845M-1444 144" x 48"

845M-1206 120" x 60" (includes double column bases)

845M-1326 132" x 60" (includes double column bases)

845M-1446 144" x 60" (includes double column bases)

845M-1686 168" x 60" (includes double column bases)

845M-1926 (Top in 3 sections) 192" x 60" (includes double column bases)

845M-2166 216" x 60" (includes double column bases)

845M-2406 240" x 60" (includes double column bases)

- Number of sectioned tops may vary based on type of stone.
- Center Located Power Unit over T-Base and Cross Base: Add \$568.

MARBLE or GRANITE TOP

ADD BASE UPGRADES

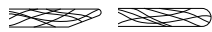

3/4" RB or 3/4" BN

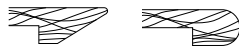

1 1/2" RB or 1 1/2" BN

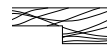

1 1/2" SQ

**ADD
CRATE
NET \$**

**SATIN +
POL
CHROME**

8324	9921	8963	134	597
10021	11850	10752	153	597
12196	14253	13018	172	664
14209	16494	15122	191	664
8238	9105	8272	134	597
10178	11173	10219	153	597
11965	13082	12011	172	664
13887	15125	13937	191	664
12324	13372	12324	208	407
14899	16120	14899	243	407
18344	19739	18344	277	509
23506	25020	23506	312	763
24952	26580	24952	347	763
26616	28361	26616	382	763
28279	30139	28279	416	763
28149	29894	28149	382	912
30087	31948	30087	420	912
32026	34001	32026	458	912
37825	40091	37825	535	1216
44417	46984	44417	611	1216
51306	54180	51306	686	1521
56408	59607	56408	762	1521

KONVERSE T and CROSS BASE TABLES • STONE TOP

See selection of top and base finishes. Standard base finish is COLORA colors; chrome base upcharges are shown below.

Tables are 29" high. Crate charges apply to stone tops.

Note: 60" wide marble tops are subject to availability – please inquire.

Specify: model number – stone top variety – edge profile – base finish – power and comm. options.

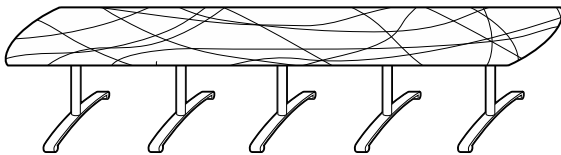
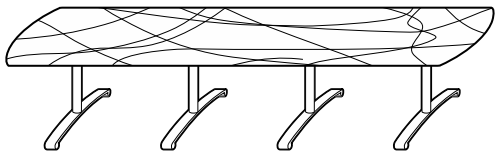
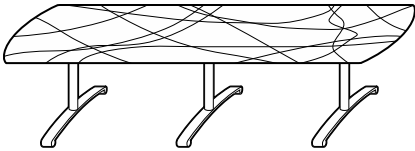
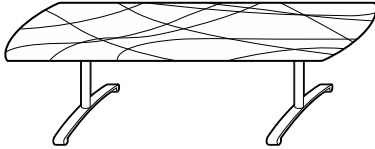
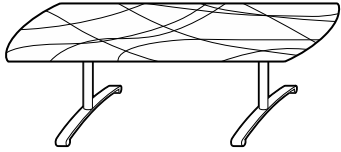

ITEM

TOP DIMENSIONS

ARCED RECTANGLE

848M-7236	72" x 36"
848M-8442	84" x 42"

848M-9648	96" x 48"
-----------	-----------

sectioned tops

848M-1084	108" x 48"
848M-1204	120" x 48"
848M-1324	132" x 48"
848M-1444	144" x 48"
848M-1206	120" x 60" (includes double column bases)
848M-1326	132" x 60" (includes double column bases)
848M-1446	144" x 60" (includes double column bases)

848M-1686	168" x 60" (includes double column bases)
848M-1926 (Top in 3 sections)	192" x 60" (includes double column bases)

848M-2166	216" x 60" (includes double column bases)
848M-2406	240" x 60" (includes double column bases)

- Number of sectioned tops may vary based on type of stone.
- Center Located Power Unit over T-Base: Add \$568.

MARBLE or GRANITE TOP

ADD BASE UPGRADES

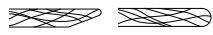

3/4" RB or 3/4" BN

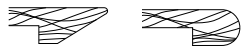

1 1/2" RB or 1 1/2" BN

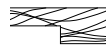

1 1/2" SQ

**ADD
CRATE
NET \$**

**SATIN +
POL
CHROME**

12980	14551	13330	208	407
15758	17589	16164	243	407
19433	21526	19898	277	509
24703	26913	25168	312	763
26255	28581	26719	347	763
28025	30467	28488	382	763
29796	32355	30260	416	763
29777	32395	30359	382	912
31850	34582	32431	420	912
33920	36770	34502	458	912
40044	43188	40641	535	1216
47098	50580	47709	611	1216
54205	58019	54831	686	1521
59672	63830	60311	762	1521

KONVERSE T and CROSS BASE TABLES • STONE TOP

See selection of top and base finishes. Standard base finish is COLORA colors; chrome base upcharges are shown below.

Tables are 29" high. Crate charges apply to stone tops.

Note: 60" wide marble tops are subject to availability – please inquire.

Specify: model number – stone top variety – edge profile – base finish – power and comm. options.

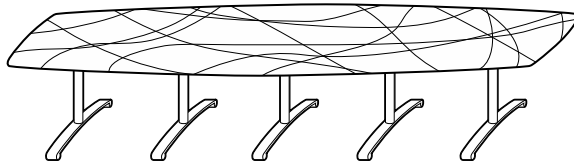
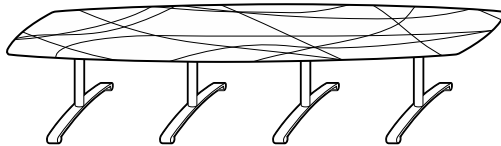
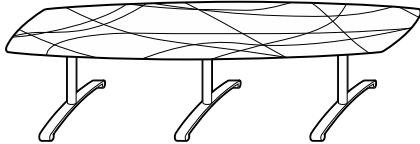
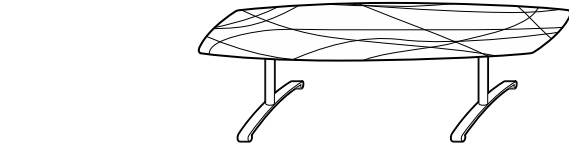
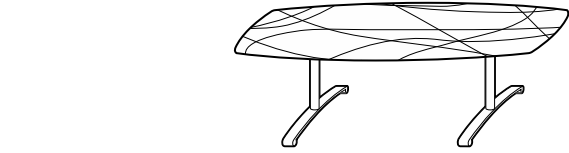

ITEM

TOP DIMENSIONS

ARCED BOAT

846M-7236	72" x 36"/25"
846M-8442	84" x 42"/30"

846M-9648	96" x 48"/35"
-----------	---------------

sectioned tops

846M-1084	108" x 48"/35"
846M-1204	120" x 48"/35"
846M-1324	132" x 48"/35"
846M-1444	144" x 48"/35"
846M-1206	120" x 60"/42" (includes double column bases)
846M-1326	132" x 60"/42" (includes double column bases)
846M-1446	144" x 60"/42" (includes double column bases)

846M-1686	168" x 60"/42" (includes double column bases)
846M-1926 (Top in 3 sections)	192" x 60"/42" (includes double column bases)

846M-2166	216" x 60"/42" (includes double column bases)
846M-2406	240" x 60"/42" (includes double column bases)

- Number of sectioned tops may vary based on type of stone.
- Center Located Power Unit over T-Base: Add \$568.

MARBLE or GRANITE TOP

ADD BASE UPGRADES

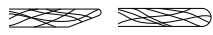

3/4" RB or 3/4" BN

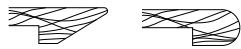

1 1/2" RB or 1 1/2" BN

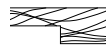

1 1/2" SQ

**ADD
CRATE
NET \$**

**SATIN +
POL
CHROME**

13330	15947	14376	208	407
16164	19219	17385	243	407
19842	23333	21239	277	509
23793	27574	25305	312	763
26836	30908	28464	347	763
28664	33027	30410	382	763
30494	35147	32355	416	763
30359	34721	32104	382	912
32489	37142	34349	420	912
34620	39563	36596	458	912
40879	46532	43142	535	1216
48076	54488	50640	611	1216
55329	62521	58207	686	1521
60951	68948	64150	762	1521

SQUARE EDGE PLATE BASE TABLES • LAMINATE and VENEER TOPS

Laminate tops with wood or COLORA edge feature 1/8" dia. vinyl inlay in COLORA between top surface and edge. Standard base finish is COLORA colors; polished and satin chrome are available at upcharge.

Tables are 29" high.

Specify: model number – top finish – edge profile and finish – inlay color (if applicable) – base finish – options.



ITEM

DIMENSIONS

ROUND

941-30	30" dia.
941-36	36" dia.
941-42	42" dia.
941-48	48" dia.
941-54	54" dia.
941-60	60" dia.

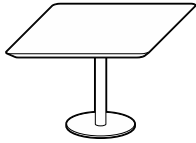

SQUARE

942-30	30" x 30"
942-36	36" x 36"
942-42	42" x 42"
942-48	48" x 48"

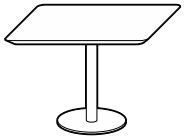

RECTANGLE

943-3024	30" x 24"
943-3630	36" x 30"
943-4230	42" x 30"
943-4830	48" x 30"
943-4836	48" x 36"
943-6030	60" x 30"
943-6036	60" x 36"

• Center Located Power Unit over Column Plate Base: Add \$568.

PLASTIC LAMINATE TOP

VENEER TOP

 <p>Flat Vinyl</p>			 <p>Square Wood</p>			 <p>Angle Wood</p>			 <p>Square Wood</p>			ADD FLIP TOP	ADD SATIN CHROME	ADD POL CHROME
QTY1	QTY3	QTY10	QTY1	QTY3	QTY10	QTY1	QTY3	QTY10	QTY1	QTY3	QTY10			

1282	1163	1016	2274	1859	1540	2964	2381	1985	233	197	319
1473	1338	1180	2501	2079	1732	3298	2689	2262	233	226	365
1679	1525	1353	2755	2318	1941	3610	2975	2521	233	226	365
2060	1883	1697	3232	2783	2357	4139	3479	2992	233	249	422
2320	2243	2144	3556	3339	2848	4497	4062	3527	357	249	422
3016	2744	2486	4362	3834	3280	5145	4418	3853		324	558

1295	1179	1031	2136	1751	1470	2357	1880	1636	233	226	365
1436	1303	1147	2330	1920	1623	2676	2145	1891	233	226	365
1814	1661	1489	2742	2307	1986	3214	2627	2362	233	249	422
2004	1831	1643	2990	2524	2185	3577	2941	2664	357	249	422

1183	1073	932	1996	1621	1349	2159	1709	1469	233	197	319
1359	1235	1083	2224	1829	1542	2479	1988	1740	233	226	365
1426	1294	1138	2314	1907	1611	2615	2100	1852	233	226	365
1715	1573	1407	2635	2214	1907	2946	2411	2160	233	249	422
1806	1653	1482	2749	2314	1994	3156	2587	2331	233	249	422
1830	1675	1500	2805	2363	2040	3221	2644	2383	233	249	422
1969	1799	1614	2967	2502	2164	3503	2862	2593	357	249	422

• Standing Height, 40" or 42": \$110.00

BEVELED EDGE PLATE BASE TABLES • VIDRO PAINTED BACK GLASS TOP

See standard color choices. Customer's own color must be pre-approved through custom quotation. Steel plate base standard in COLORA; Polished and Satin Chrome options upcharged. Plate bases in Round (R) and Square (S) can be specified. Standard with 3/4" beveled edge profile. Bases do not provide internal wire management option. Column 3" dia. up to 20" dia. base; 4" dia. for all bases 24" dia. and above. Tables are 29" high.

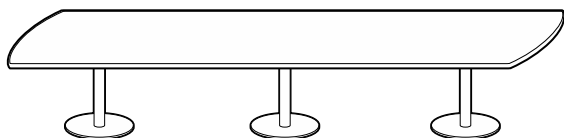
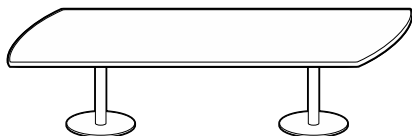
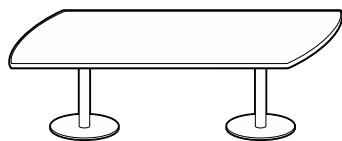
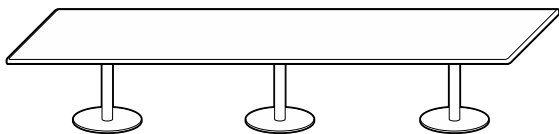
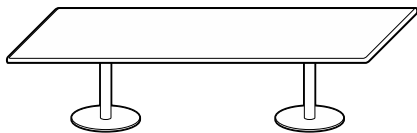
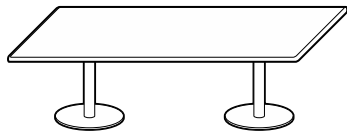
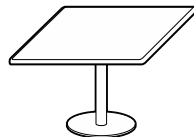
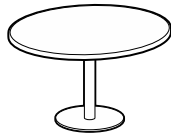
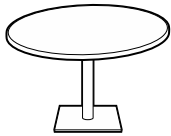

ITEM	RD BASE = R	TOP DIMENSIONS	BASE DIMENSIONS	
	SQ BASE = S		RD	SQ
ROUND				
901V-30	R or S	30" dia.	20" dia.	20" x 20"
901V-36	R or S	36" dia.	20" dia.	20" x 20"
901V-42	R or S	42" dia.	24" dia.	24" x 24"
901V-48	R or S	48" dia.	24" dia.	24" x 24"
901V-54	R or S	54" dia.	28" dia.	28" x 28"
901V-60	R or S	60" dia.	28" dia.	28" x 28"

ITEM	RD BASE = R	TOP DIMENSIONS	BASE DIMENSIONS	
	SQ BASE = S		RD	SQ
SQUARE				
907V-42	R or S	42" x 42"	24" dia.	24" x 24"
907V-48	R or S	48" x 48"	28" dia.	28" x 28"

ITEM	RD BASE = R	TOP DIMENSIONS	BASE DIMENSIONS	
	SQ BASE = S		RD	SQ
RECTANGLE				
905V-7236	R or S	72" x 36"	20" dia.	20" x 20"
905V-8442	R or S	84" x 42"	24" dia.	24" x 24"
905V-9648	R or S	96" x 48"	28" dia.	28" x 28"
905V-1084 (Top 2 sections)	R or S	108" x 48"	28" dia.	28" x 28"

ITEM	RD BASE = R	TOP DIMENSIONS	BASE DIMENSIONS	
	SQ BASE = S		RD	SQ
sectioned tops				
905V-1204	R or S	120" x 48"	28" dia.	28" x 28"
905V-1324	R or S	132" x 48"	28" dia.	28" x 28"
905V-1444	R or S	144" x 48"	28" dia.	28" x 28"
905V-1206	R or S	120" x 60"	28" dia.	28" x 28"
905V-1326	R or S	132" x 60"	28" dia.	28" x 28"
905V-1446	R or S	144" x 60"	28" dia.	28" x 28"

905V-1686	R or S	168" x 60"	28" dia.	28" x 28"
905V-1926 (Top 3 sections)	R or S	192" x 60"	28" dia.	28" x 28"
905V-2166 (Top 3 sections)	R or S	216" x 60"	28" dia.	28" x 28"
905V-2406 (Top 4 sections)	R or S	240" x 60"	28" dia.	28" x 28"

ITEM	RD BASE = R	TOP DIMENSIONS	BASE DIMENSIONS	
	SQ BASE = S		RD	SQ
ARCED RECTANGLE				
908V-7236	R or S	72" x 36"	20" dia.	20" x 20"
908V-8442	R or S	84" x 42"	24" dia.	24" x 24"
908V-9648	R or S	96" x 48"	28" dia.	28" x 28"
908V-1048 (Top 2 sections)	R or S	108" x 48"	28" dia.	28" x 28"

ITEM	RD BASE = R	TOP DIMENSIONS	BASE DIMENSIONS	
	SQ BASE = S		RD	SQ
sectioned tops				
908V-1204	R or S	120" x 48"	28" dia.	28" x 28"
908V-1324	R or S	132" x 48"	28" dia.	28" x 28"
908V-1444	R or S	144" x 48"	28" dia.	28" x 28"
908V-1206	R or S	120" x 60"	28" dia.	28" x 28"
908V-1326	R or S	132" x 60"	28" dia.	28" x 28"
908V-1446	R or S	144" x 60"	28" dia.	28" x 28"

908V-1686	R or S	168" x 60"	28" dia.	28" x 28"
908V-1926 (Top 3 sections)	R or S	192" x 60"	28" dia.	28" x 28"
908V-2166 (Top 3 sections)	R or S	216" x 60"	28" dia.	28" x 28"
908V-2406 (Top 4 sections)	R or S	240" x 60"	28" dia.	28" x 28"

• Center Located Power Unit over Column Plate Base: Add \$568.

PAINTED BACK GLASS TOP (CL GLASS)

MATTE (MA GLASS)

ADD BASE UPGRADES

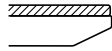

1 1/4" RB

QTY1 QTY3

2587 2229
2989 2629
3854 3456
4677 4143
5663 5090
6639 6047

4121 3627
4889 4360

6743 6352
8069 7583
9788 8861
10514 9588

12511 11468
13243 12192
14106 13062
14280 13195
15398 14310
16513 15429

19327 18465
22384 21525
24648 23622
26510 25315

7292 6900
8816 8329
10762 9836
11610 10685

13730 12687
14584 13533
15567 14525
15803 14720
17074 15987
18341 17256

21459 20598
24822 23963
26857 25831
29425 28229

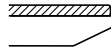

1 1/4" RB

QTY1 QTY3

3051 2669
3611 3227
4695 4273
5782 5199
7022 6399
8278 7637

5012 4469
5978 5400

8054 7614
9753 9218
11901 10926
12867 11893

15347 14157
16295 15097
17397 16207
17653 16423
19091 17857
20523 19293

23876 22869
27764 26759
30664 29493
33090 31748

8693 8253
10624 10087
13037 12061
14144 13171

16767 15578
17858 16660
19099 17914
19429 18200
21043 19810
23193 21963

26361 25354
30605 29599
33326 32155
36508 35165

ADD
CRATE
NET \$

94
114
134
153
172
191

134
153

208
243
277
312

347
382
416
382
420
458

535
611
686
762

208
243
277
312

347
382
416
382
420
458

535
611
686
762

RD BASE POL &
SATIN CHROME +
SQ BASE BRUSH STAIN

486
486
583
583
721
721

583
721

973
1165
1440
1440

1440
1440
1440
1460
1460
1460

2189
2189
2189
2189

973
1165
1440
1440

1440
1440
1440
1460
1460
1460

2189
2189
2189
2189

SQ BASE
POL STAIN

575
575
781
781
932
932

781
932

1149
1561
1864
1864

1864
1864
1864
2038
2038
2038

3055
3055
3055
3055

1149
1561
1864
1864

1864
1864
1864
2038
2038
2038

3055
3055
3055
3055

PLATE BEVELED EDGE

• Beveled Edge Plate Profile:

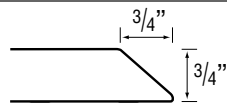

• Vidro Art option require additional details - custom quote required.

BEVELED EDGE PLATE BASE TABLES • VIDRO PAINTED BACK GLASS TOP

See standard color choices. Customer's own color must be pre-approved through custom quotation. Steel plate base standard in COLORA; Polished and Satin Chrome options upcharged. Plate bases in Round (R) and Square (S) can be specified. Standard with 3/4" beveled edge profile. Bases do not provide internal wire management option. Column 3" dia. up to 20" dia. base; 4" dia. for all bases 24" dia. and above. Tables are 29" high.

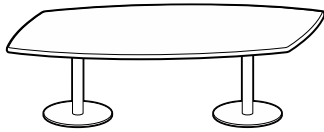

ITEM	RD BASE = R	TOP DIMENSIONS	BASE DIMENSIONS	
	SQ BASE = S		RD	SQ
ARCED BOAT				
906V-7236	R or S	72" x 36"/34"	20" dia.	20" x 20"
906V-8442	R or S	84" x 42"/30"	24" dia.	24" x 24"
906V-9648	R or S	96" x 48"/35"	28" dia.	28" x 28"
906V-1084 (Top 2 sections)	R or S	108" x 48"/35"	28" dia.	28" x 28"



sectioned tops				
906V-1204	R or S	120" x 48"/35"	28" dia.	28" x 28"
906V-1324	R or S	132" x 48"/35"	28" dia.	28" x 28"
906V-1444	R or S	144" x 48"/35"	28" dia.	28" x 28"
906V-1206	R or S	120" x 60"/42"	28" dia.	28" x 28"
906V-1326	R or S	132" x 60"/42"	28" dia.	28" x 28"
906V-1446	R or S	144" x 60"/42"	28" dia.	28" x 28"

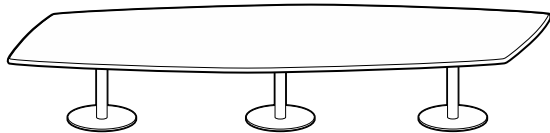

906V-1686	R or S	168" x 60"/42"	28" dia.	28" x 28"
906V-1926 (Top 3 sections)	R or S	192" x 60"/42"	28" dia.	28" x 28"
906V-2166 (Top 3 sections)	R or S	216" x 60"/42"	28" dia.	28" x 28"
906V-2406 (Top 4 sections)	R or S	240" x 60"/42"	28" dia.	28" x 28"

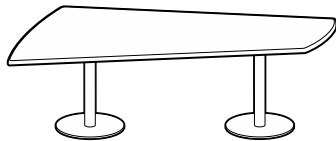

ARCED WEDGE				
909V-8448	R or S	84" x 48"/28"	28"/20" dia.	28" / 20"
909V-9648	R or S	96" x 48"/28"	28"/20" dia.	28" / 20"
909V-1084 (Top 2 sections)	R or S	108" x 48"/28"	28"/20" dia.	28" / 20"

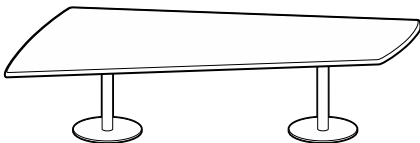

sectioned tops				
909V-1206	R or S	120" x 60"/35"	28" / 24" dia.	28" / 24"
909V-1326	R or S	132" x 60"/35"	28" / 24" dia.	28" / 24"
909V-1446	R or S	144" x 60"/35"	28" / 24" dia.	28" / 24"

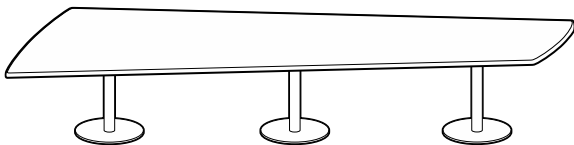

909V-1686	R or S	168" x 60"/35"	28"/28"/24" dia.	28"/28"/24"
909V-1926 (Top 3 sections)	R or S	192" x 60"/35"	28"/28"/24" dia.	28"/28"/24"
909V-2166 (Top 3 sections)	R or S	216" x 60"/35"	28"/28"/24" dia.	28"/28"/24"
909V-2406 (Top 4 sections)	R or S	240" x 60"/35"	28"/28"/24" dia.	28"/28"/24"

• Center Located Power Unit over Column Plate Base: Add \$568.

PAINTED BACK GLASS TOP (CL GLASS)

MATTE (MA GLASS)

ADD BASE UPGRADES

				ADD CRATE NET \$	RD BASE POL & SATIN CHROME + SQ BASE BRUSH STAIN	SQ BASE POL STAIN
1 1/4" RB		1 1/4" RB				
QTY1	QTY3	QTY1	QTY3			
7292	6900	8693	8253	208	973	1149
8816	8329	10624	10087	243	1165	1561
10762	9836	13037	12061	277	1440	1864
11610	10685	14144	13171	312	1440	1864
13730	12687	16767	15578	347	1440	1864
14584	13533	17858	16660	382	1440	1864
15567	14525	19099	17912	416	1440	1864
15803	14720	19429	18200	382	1460	2038
17074	15987	21043	19810	420	1460	2038
18341	17256	22654	21423	458	1460	2038
21459	20598	26361	25354	535	2189	3055
24822	23963	30605	29599	611	2189	3055
27390	26364	33860	32688	686	2189	3055
29557	28362	36640	35298	762	2189	3055
9467	8991	11481	10956	243	1207	1506
10300	9403	12575	11629	277	1207	1506
11149	10252	13683	12738	312	1207	1506
15288	14233	18914	17714	382	1314	1799
16551	15503	20521	19326	420	1314	1799
17815	16772	22128	20939	458	1314	1799
20932	19899	25834	24656	535	2034	2731
24296	23263	30079	28900	611	2034	2731
26864	25663	33333	31987	686	2034	2731
29031	27663	36113	34600	762	2034	2731

PLATE BEVELED EDGE



• Vidro Art option require additional details - custom quote required.

KABLE T AND CROSS BASE TABLES • LAMINATE and VENEER TOPS

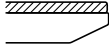
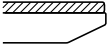
Laminate tops with wood or COLORA edge feature 1/8" dia. vinyl inlay in COLORA between top surface and edge. Standard base finish is COLORA colors; removable ribbed base cover strips can be specified in contrast color. Tables are 29" high.

Specify: model number – top finish – edge profile and finish – inlay color (if applicable) – base finish – options.



ITEM

DIMENSIONS

ROUND

One-Column

1101-30	30" dia.
1101-36	36" dia.
1101-42	42" dia.
1101-48	48" dia.



Four-Column

Center Space for Power & Comm. Units

1101-48P	48" dia.
1101-54P	54" dia.
1101-60P	60" dia.



SQUARE

One-Column

1102-30	30" x 30"
1102-36	36" x 36"
1102-42	42" x 42"

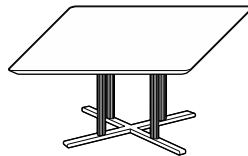

Four-Column

Center Space for Power & Comm. Units

1102-42P	42" x 42"
1102-48P	48" x 48"
1102-54P	54" x 54"
1102-60P	60" x 60"

PLASTIC LAMINATE TOP

VENEER TOP

										
	Flat Vinyl		Square Wood			Angel Wood		Square Wood		ADD
QTY1	QTY3	QTY10	QTY1	QTY3	QTY10	QTY1	QTY3	QTY10	FLIP	TOP

1482	1336	1219	2473	2033	1744	3163	2552	2188	233
1643	1478	1351	2669	2220	1903	3467	2829	2435	233
1858	1677	1535	2934	2469	2120	3788	3127	2701	233
2061	1856	1701	3234	2756	2362	4140	3452	2996	233

2654	2395	2206	3825	3295	2866	4732	3992	3502	
2915	2634	2426	4149	3601	3129	5088	4326	3806	
3352	3020	2779	4701	4111	3572	5484	4694	4145	

1466	1319	1204	2305	1891	1643	2524	2021	1809	233
1616	1454	1327	2508	2073	1803	2855	2296	2073	233
1815	1635	1494	2743	2281	1990	3215	2601	2367	233

2408	2174	1998	3333	2816	2494	3806	3140	2869	
2610	2356	2163	3597	3050	2703	4184	3465	3184	
2845	2567	2359	3860	3282	2917	4641	3825	3545	
3220	2899	2661	4298	3673	3265	5170	4664	3946	

KABLE T and CROSS

- Self Edge Laminate available at same price as Vinyl Edge.
- Black Lockable Casters (3" dia.): \$99.00 per table. Always recommended for Flip Top tables.
- Option: Infinity Lockable Casters: \$223.00 per table.
- Standing Height, 40" or 42": \$110.00 Single Column.

KABLE T AND CROSS BASE TABLES • LAMINATE and VENEER TOPS

Laminate tops with wood or COLORA edge feature 1/8" dia. vinyl inlay in COLORA between top surface and edge. Standard base finish is COLORA colors; removable ribbed base cover strips can be specified in contrast color. Tables are 29" high.

Specify: model number – top finish – edge profile and finish – inlay color (if applicable) – base finish – options.

ITEM DIMENSIONS

RECTANGLE

1103-7236	72" x 36"
1103-7242	72" x 42"
1103-8442	84" x 42"
1103-9642	96" x 42"
1103-9648	96" x 48"
1103-1084	108" x 48"

1103-1204	120" x 48"
1103-1444	144" x 48"
1103-1446	144" x 60"

1103-1686	168" x 60"
1103-1926	192" x 60"

1103-2166	216" x 60"
1103-2406 (Top in 3 sections)	240" x 60"

RACETRACK

1104-7236	72" x 36"
1104-8442	84" x 42"
1104-9642	96" x 42"
1104-9648	96" x 48"
1104-1084	108" x 48"

1104-1204	120" x 48"
1104-1444	144" x 48"
1104-1446	144" x 60"

1104-1686	168" x 60"
1104-1926	192" x 60"

1104-2166	216" x 60"
1104-2406 (Top in 3 sections)	240" x 60"

• Center Located Power Unit over T-Base: Add \$568.

PLASTIC LAMINATE TOP

VENEER TOP

Flat Vinyl			Square Wood			Angle Wood			Square Wood			ADD FLIP TOP
QTY1	QTY3	QTY10	QTY1	QTY3	QTY10	QTY1	QTY3	QTY10	QTY1	QTY3	QTY10	
2111	2006	1936	3157	2755	2523	3826	3207	3061				569
2587	2458	2372	3639	3209	2961	4399	3720	3561				640
2789	2640	2544	3864	3415	3141	4788	4040	3876				808
3150	2963	2840	4283	3790	3480	5210	4442	4224				1005
3574	3371	3237	4735	4223	3902	5913	5018	4836				1005
4057	3804	3635	5229	4661	4305	6343	5371	5175				1049
5043	4790	4620	6486	5763	5399	8222	7380	6824				
5555	5244	5032	7093	6300	5880	9084	8088	7510				
5747	5412	5188	7324	6512	6058	9995	8881	8289				
7375	6969	6696	9117	8179	7649	12169	10855	10170				
8386	7865	7519	10273	9162	8529	13353	11869	11076				
9731	9145	8754	11985	10802	10078	15289	13618	12520				
10318	9668	9235	13046	11734	10943	17063	15205	13798				
2648	2499	2397	4244	3749	3379	4504	3879	3611				569
3344	3135	2998	5037	4432	4019	5443	4640	4358				808
3656	3420	3262	5423	4754	4316	5899	5005	4712				1005
4263	3991	3812	6047	5321	4862	6639	5637	5334				1005
4871	4535	4311	6694	5868	5361	7115	5986	5668				1049
6127	5761	5519	8299	7406	6877	9536	7839	7468				
6895	6450	6151	9191	8110	7551	10096	8566	8176				
7416	6913	6577	9726	8567	7985	11079	9375	8969				
9452	8836	8425	11856	10543	9833	13004	11220	10790				
10230	9531	9066	12758	11288	10514	14248	12075	11625				
11803	11017	10492	14621	12966	12102	16439	14445	13336				
12637	11761	11176	15990	14156	13185	18332	16130	14681				

KABLE T and CROSS

- Self Edge Laminate available at same price as Vinyl Edge.
- Black Lockable Casters (3" dia.): \$51.00 per T Base. Always recommended for Flip Top tables.
- Option: Infinity Lockable Casters: \$110.00 per T Base.

KABLE T AND CROSS BASE TABLES • LAMINATE and VENEER TOPS

Laminate tops with wood or COLORA edge feature 1/8" dia. vinyl inlay in COLORA between top surface and edge. Standard base finish is COLORA colors; removable ribbed base cover strips can be specified in contrast color. Tables are 29" high.

Specify: model number – top finish – edge profile and finish – inlay color (if applicable) – base finish – options.



ITEM

DIMENSIONS

BOAT

1105-7236	72" x 36"/25"
1105-8442	84" x 42"/30"
1105-9642	96" x 42"/30"
1105-9648	96" x 48"/35"
1105-1084	108" x 48"/35"

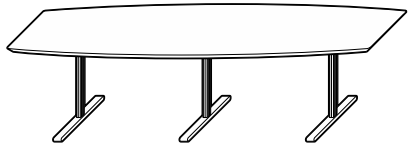

1105-1204	120" x 48"/35"
1105-1444	144" x 48"/35"
1105-1446	144" x 60"/42"

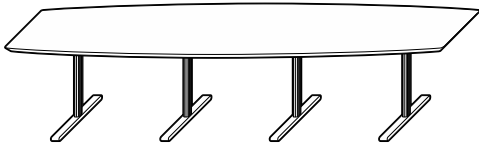

1105-1686	168" x 60"/42"
1105-1926	192" x 60"/42"

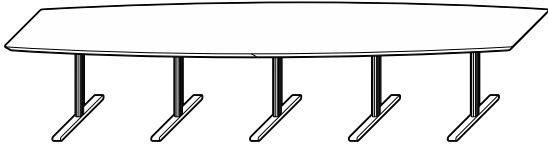

1105-2166	216" x 60"/42"
1105-2406 (Top in 3 sections)	240" x 60"/42"

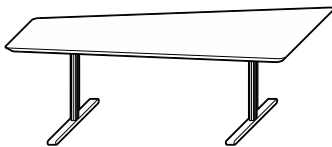

WEDGE

1106-8448	84" x 48"/28"
1106-9648	96" x 48"/28"
1106-1084	108" x 48"/28"

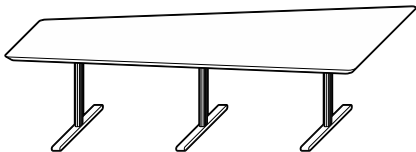

1106-1206	120" x 60"/35"
1106-1446	144" x 60"/35"

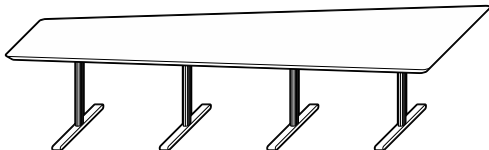

1106-1686	168" x 60"/35"
1106-1926	192" x 60"/35"

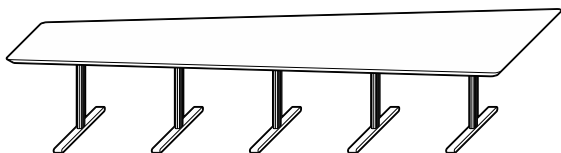

1106-2166	216" x 60"/35"
1106-2406 (Top in 3 sections)	240" x 60"/35"

• Center Located Power Unit over T-Base: Add \$568.

PLASTIC LAMINATE TOP

VENEER TOP

Flat Vinyl			Square Wood			Angle Wood		Square Wood		ADD FLIP TOP
QTY1	QTY3	QTY10	QTY1	QTY3	QTY10	QTY1	QTY3	QTY10		

2648	2499	2397	4244	3749	3379	4504	3879	3611	569
3377	3171	3031	5019	4414	4000	5425	4624	4340	808
3668	3434	3275	5406	4735	4298	5883	4987	4694	1005
4244	3975	3795	6030	5306	4845	6621	5620	5317	1005
4854	4517	4308	6676	5851	5343	7097	5969	5651	1049

6173	5801	5552	8336	7435	6901	9510	7813	7442	
6869	6422	6124	9166	8083	7524	10070	8540	8149	
7935	7377	7004	10191	8975	8356	11461	9594	9173	

10062	9381	8927	12400	11021	10267	13448	11480	11031	
10931	10157	9640	13381	11836	11013	14757	12367	11899	

11803	11017	10492	14621	12966	12102	16439	14445	13336	
12637	11761	11176	15990	14156	13185	18332	16130	14681	

3787	3529	3359	4794	4233	3878	5232	4389	4197	808
4438	4144	3947	5486	4880	4499	5992	5073	4868	1005
4854	4517	4294	5899	5247	4838	6422	5427	5207	1049

7218	6729	6408	8474	7511	6980	8913	8022	7418	
8120	7538	7150	9405	8324	7724	9869	8821	8197	

10101	9415	8959	11396	10188	9510	11763	10614	9822	
10971	10190	9673	12307	10977	10230	12674	11425	10672	

12069	11250	10705	14885	13199	12312	16439	14445	13336	
12932	12021	11413	16285	14417	13420	18332	16130	14681	

- Self Edge Laminate available at same price as Vinyl Edge.
- Black Lockable Casters (3" dia.): \$51.00 per T Base. Always recommended for Flip Top tables.
- Option: Infinity Lockable Casters: \$110.00 per T Base.

KABLE C BASE TRAINING TABLES • LAMINATE and VENEER TOPS

Laminate tops with wood or COLORA edge feature 1/8" dia. vinyl inlay in COLORA between top surface and edge. Standard base finish is COLORA colors; removable ribbed base cover strips can be specified in contrast color. Modesty panels are in COLORA colors. Tables are 29" high.
Specify: model number – top finish – edge profile and finish – inlay color (if applicable) – base finish – modesty finish – options.

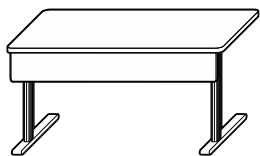
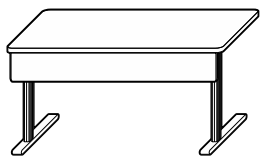
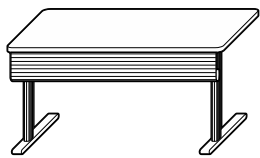
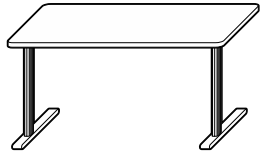

ITEM DIMENSIONS

WITHOUT MODESTY PANEL

1121-4220	42" x 20"	
1121-4820	48" x 20"	
1121-6020	60" x 20"	
1121-7220	72" x 20"	C-Bases located 6" from end of table
1121-4224	42" x 24"	(non-folding only)
1121-4824	48" x 24"	
1121-6024	60" x 24"	
1121-7224	72" x 24"	
1121-4830	48" x 30"	
1121-6030	60" x 30"	
1121-7230	72" x 30"	

WITH J MODESTY PANEL (REMOVABLE)

Extruded aluminum modesty panel in ribbed pattern features a large wire management tray. 7 1/2" high. Removable (without tools) for folding base tables.

1122-4220	42" x 20"	
1122-4820	48" x 20"	
1122-6020	60" x 20"	
1122-7220	72" x 20"	C-Bases located 6" from end of table
1122-4224	42" x 24"	(non-folding only)
1122-4824	48" x 24"	
1122-6024	60" x 24"	
1122-7224	72" x 24"	
1122-4830	48" x 30"	
1122-6030	60" x 30"	
1122-7230	72" x 30"	

WITH FLAT FIXED MODESTY

Flat aluminum modesty panel fixed to table top, 9" high.

1125-4220	42" x 20"	
1125-4820	48" x 20"	
1125-6020	60" x 20"	
1125-7220	72" x 20"	C-Bases located 6" from end of table
1125-4224	42" x 24"	(non-folding only)
1125-4824	48" x 24"	
1125-6024	60" x 24"	
1125-7224	72" x 24"	
1125-4830	48" x 30"	
1125-6030	60" x 30"	
1125-7230	72" x 30"	

WITH FLAT FOLDING MODESTY

Utilized with Folding Base or Flip Top options - add costs. Flat aluminum modesty panel is 9" high and folds over bases in folded position or over table underside with flip top option.

1124-6024	60" x 24"	C-Bases located 6" from end of table
1124-7224	72" x 24"	(non-folding only)
1124-6030	60" x 30"	
1124-7230	72" x 30"	

BRIDGE TOP - Connector plates included

90-deg PIE

996-20	20" R x 20"
996-24	24" R x 24"
996-30	30" R x 30"

45-deg PIE

997-20	20" R x 20"
997-24	24" R x 24"
997-30	30" R x 30"

30-deg PIE

998-20	20" R x 20"
998-24	24" R x 24"
998-30	30" R x 30"

GANG SET

Each set \$96.00 factory installed. Consists of two brackets, a linking bar and two thumb screws. Ganging 24", 30" and 36" sides requires 1 set; 42" sides and over requires 2 sets.

PLASTIC LAMINATE TOP

VENEER TOP



Flat Vinyl



Square Wood



Square Wood

QTY1	QTY3	QTY10	QTY1	QTY3	QTY10	QTY1	QTY3	QTY10	ADD FOLDING BASE*	ADD FLIP TOP
1335	1289	1258	2236	1914	1743	2438	2012	1889		569
1349	1301	1271	2248	1928	1756	2473	2048	1924		569
1500	1440	1404	2452	2110	1924	2726	2271	2144	471	569
1664	1591	1545	2672	2309	2107	2983	2494	2363	471	569
1341	1296	1265	2242	1920	1748	2484	2060	1936		569
1356	1309	1279	2254	1933	1760	2519	2093	1971		569
1507	1450	1411	2461	2118	1933	2785	2330	2202	471	569
1672	1600	1554	2682	2317	2116	3052	2566	2434	471	569
1502	1440	1402	2422	2081	1898	2731	2280	2150		569
1661	1587	1537	2635	2274	2076	3050	2557	2420	471	569
1833	1746	1687	2865	2481	2265	3392	2829	2689	471	569
1804	1663	1602	2709	2290	2089	2909	2387	2236		
1839	1698	1638	2741	2356	2120	2964	2441	2291		
2032	1870	1810	2986	2547	2332	3256	2709	2550	471	
2233	2068	1993	3245	2786	2554	3557	2973	2811	471	
1813	1671	1612	2714	2295	2094	2955	2435	2283		569
1848	1704	1646	2745	2327	2129	3011	2490	2339		569
2040	1887	1819	2992	2554	2340	3316	2767	2610	471	569
2246	2078	2001	3253	2796	2563	3626	3042	2879	471	569
1993	1836	1767	2913	2477	2265	3223	2673	2518		569
2193	2022	1943	3167	2711	2483	3583	2992	2826	471	569
2408	2220	2134	3438	2957	2714	3963	3306	3135	471	569
1622	1535	1482	2598	2162	1967	2726	2260	2115		
1656	1571	1515	2557	2197	1998	2781	2317	2170		
1821	1726	1663	2775	2396	2185	3049	2557	2403		
2054	1945	1873	3065	2664	2436	3376	2849	2691		
1630	1543	1489	2529	2169	1972	2772	2307	2161		569
1664	1579	1524	2562	2202	2005	2827	2364	2216		569
1832	1734	1670	2783	2403	2191	3106	2614	2462		569
2065	1955	1883	3074	2672	2442	3447	2920	2760		569
1810	1712	1644	2728	2350	2143	3041	2548	2396		569
1983	1872	1795	2957	2559	2336	3373	2841	2678		569
2228	2100	2016	3255	2836	2594	3783	3184	3017		569
2149	2024	1958	3100	2694	2479	3424	2904	2749	471	569
2425	2238	2133	3432	2954	2694	3805	3201	3011	471	569
2301	2163	2083	3274	2849	2623	3690	3131	2966	471	569
2587	2383	2266	3616	3118	2843	4143	3467	3267	471	569
473	445	426	1052	895	790	912	805	744		
498	466	445	1075	917	813	984	877	813		
543	505	480	1137	978	871	1041	935	871		
449	421	402	1028	871	767	834	725	664		
473	443	421	1052	895	790	902	796	733		
520	481	459	1114	955	849	939	831	770		
440	410	390	1015	858	756	785	678	614		
466	434	412	1025	882	777	795	686	624		
504	469	445	1098	941	832	805	697	635		

KABLE C TRAINING

- Self Edge Laminate available at same price as Vinyl Edge.
- Black Lockable Casters (3" dia.): \$51.00 per C Base. Always recommended for Flip Top tables.
- Option: Infinity Lockable Casters: \$110.00 per C Base.
- Standing Height, 40" or 42": \$168.00
- *• 60" long folding tables have narrow range of suitable Surface Power Units based on location(s) and quantity - please inquire

KABLE T BASE TABLES • MODULAR MEETING • LAMINATE and VENEER TOPS

Laminate tops with wood or COLORA edge feature 1/8" dia. vinyl inlay in COLORA between top surface and edge. Standard base finish is COLORA colors; removable ribbed base cover strips can be specified in contrast color. Tables are 29" high.

Specify: model number – top finish – edge profile and finish – inlay color (if applicable) – base finish – options.

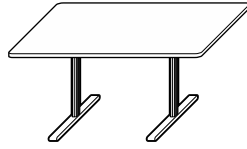

ITEM DIMENSIONS

RECTANGLE

1153-6042	60" x 42"
1153-6642	66" x 42"
1153-7242	72" x 42"
1153-6048	60" x 48"
1153-6648	66" x 48"
1153-7248	72" x 48"
1153-8448	84" x 48"
1153-9048	90" x 48"
1153-7254	72" x 54"
1153-8454	84" x 54"
1153-9054	90" x 54"

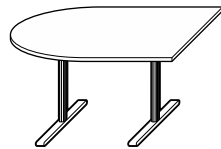

BULLET

1157-6042	60" x 42"
1157-6642	66" x 42"
1157-7242	72" x 42"
1157-6048	60" x 48"
1157-6648	66" x 48"
1157-7248	72" x 48"
1157-8448	84" x 48"
1157-9048	90" x 48"
1157-7254	72" x 54"
1157-8454	84" x 54"
1157-9054	90" x 54"



GANG SET

Each set \$96.00 factory installed.

Consists of two plates bolted to underside of adjacent tables and a linking bar and thumb screws. Gang Set connects and levels tables. 2 sets are required to connect each 2 top sides.

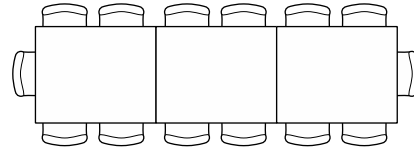
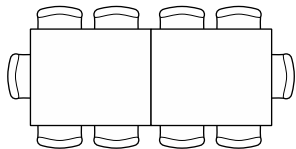

PLASTIC LAMINATE TOP

VENEER TOP



Flat Vinyl



Square Wood



Square Wood

QTY1	Flat Vinyl		Square Wood			Square Wood			ADD FLIP TOP
	QTY3	QTY10	QTY1	QTY3	QTY10	QTY1	QTY3	QTY10	
2288	2191	2123	3302	2907	2688	3997	3384	3232	579
2442	2328	2254	3475	3064	2825	4285	3572	3416	579
2587	2458	2372	3639	3209	2961	4399	3720	3561	640
2605	2480	2396	3627	3204	2957	4292	3647	3501	579
2906	2748	2643	3919	3461	3190	4513	3864	3688	579
3164	2977	2856	4209	3721	3424	4732	4081	3877	640
3447	3229	3085	4552	4028	3700	5231	4414	4241	808
3590	3357	3203	4722	4180	3838	5453	4602	4432	946
3361	3152	4377	4432	3919	3605	5071	4329	4119	640
3501	3278	3131	4629	4099	3766	5623	4728	4548	808
3687	3441	3280	4840	4287	3936	5883	4938	4748	946

2455	2342	2266	3973	3534	3201	4553	3943	3682	579
2624	2492	2405	4201	3729	3379	4785	4128	3859	579
2790	2643	2545	4432	3923	3553	5019	4316	4035	640
2813	2667	2568	4403	3914	3546	4878	4208	3945	579
3176	2992	2870	4785	4240	3846	5227	4490	4197	579
3437	3222	3079	5097	4503	4086	5631	4638	4354	640
3652	3413	3256	5415	4761	4326	5918	5025	4732	808
3810	3557	3387	5613	4927	4477	6146	5188	4901	946
3567	3339	3186	5267	4641	4212	5825	4905	4623	640
3909	3643	3467	5707	5008	4551	6352	5348	5046	808
4086	3799	3610	5928	5191	4719	6610	5548	5235	946

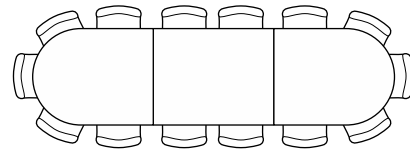
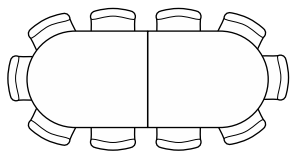

- Self Edge Laminate available at same price as Vinyl Edge.
- Black Lockable Casters (3" dia.): \$51.00 per T Base. Always recommended for Flip Top tables.
- Option: Infinity Lockable Casters: \$110.00 per T Base.

KABLE T BASE TABLES • MODULAR • LAMINATE and VENEER TOPS

Laminate tops with wood or COLORA edge feature 1/8" dia. vinyl inlay in COLORA between top surface and edge. Standard base finish is COLORA colors; removable ribbed base cover strips can be specified in contrast color. Tables are 29" high.

Specify: model number – top finish – edge profile and finish – inlay color (if applicable) – base finish – optional modesty finish – options.

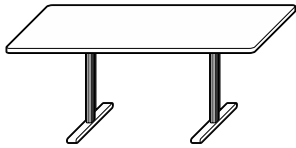

ITEM

DIMENSIONS

RECTANGLE

1133-4824	48" x 24"	
1133-6024	60" x 24"	
1133-7224	72" x 24"	
1133-8424	84" x 24"	T-Bases located 12" from end of table (non-folding only)
1133-4830	48" x 30"	
1133-6030	60" x 30"	
1133-7230	72" x 30"	
1133-8430	84" x 30"	
1133-4836	48" x 36"	
1133-6036	60" x 36"	
1133-7236	72" x 36"	
1133-8436	84" x 36"	

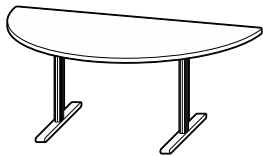

HALF ROUND

1134-48	48" dia. x 24"
1134-54	54" dia. x 27"
1134-60	60" dia. x 30"
1134-66	66" dia. x 33"
1134-72	72" dia. x 36"

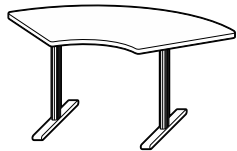

ARC

1135-3624	36" R x 24"
1135-4824	48" R x 24"
1135-4830	48" R x 30"
1135-6030	60" R x 30"
1135-6036	60" R x 36"
1135-7236	72" R x 36"

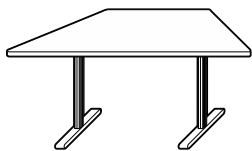

TRAPEZOID

1136-4824	48" X 24" X 24"
1136-6030	60" X 30" X 30"
1136-7236	72" X 36" X 36"



V END

170-deg PIE

1138-24 (for 24" D Tables)	54" x 30"
1138-30 (for 30" D Tables)	66" x 36"
1138-36 (for 36" D Tables)	78" x 42"

PLASTIC LAMINATE TOP

VENEER TOP



Flat Vinyl



Square Wood



Square Wood

QTY1	Flat Vinyl		Square Wood			Square Wood			ADD FOLDING BASE*	ADD FLIP TOP
	QTY3	QTY10	QTY1	QTY3	QTY10	QTY1	QTY3	QTY10		
1356	1309	1279	2254	1933	1760	2519	2093	1971		569
1507	1450	1411	2461	2118	1933	2785	2330	2202	471	569
1672	1600	1554	2682	2317	2116	3052	2566	2434	471	569
1863	1780	1726	2920	2540	2324	3387	2843	2709	471	858
1502	1440	1402	2422	2081	1898	2731	2280	2150		569
1661	1587	1537	2635	2274	2076	3050	2557	2420	471	569
1833	1746	1687	2865	2481	2265	3392	2829	2689	471	569
2074	1971	1901	3142	2739	2507	3761	3152	3000	471	858
1600	1527	1480	2544	2187	1991	2944	2453	2323		569
1800	1709	1650	2798	2414	2200	3332	2771	2628	471	569
2111	2006	1936	3157	2755	2523	3826	3207	3061	471	569
2419	2291	2206	3493	3063	2805	4244	3566	3409	471	858
1637	1564	1514	2704	2343	2138	3170	2636	2401		569
1819	1724	1664	2912	2529	2305	3340	2798	2558		569
2043	1928	1850	3146	2745	2496	3601	3041	2781		569
2264	2123	2030	3392	2966	2697	3810	3240	2972		569
2599	2431	2324	3738	3291	2996	4200	3603	3316		569
1591	1522	1477	3029	2629	2427	3299	2825	2591		569
1840	1747	1686	3332	2891	2662	3969	3382	3128		569
2059	1943	1865	3540	3075	2830	4088	3461	3195		569
2293	2148	2053	3920	3394	3117	4758	4054	3776		655
2533	2359	2243	4169	3612	3316	4983	4182	3898		655
2932	2724	2587	4685	4059	3727	6116	5113	4811		764
1558	1491	1447	2435	2092	1908	2568	2133	2002		569
1951	1843	1770	2869	2477	2257	3054	2550	2406		569
2382	2232	2133	3342	2897	2640	3712	3082	2925		569
1759	1674	1617	3209	2783	2566	3217	2675	2437		569
1995	1887	1814	3530	3050	2807	3666	3094	2825		579
2461	2312	2214	4083	3531	3245	4260	3645	3350		729

- Self Edge Laminate available at same price as Vinyl Edge.
- Black Lockable Casters (3" dia.): \$51.00 per T Base. Always recommended for Flip Top tables.
- Option: Infinity Lockable Casters: \$110.00 per T Base.
- Standing Height, 40" or 42": \$153.00
- *• 60" long folding tables have narrow range of suitable Surface Power Units based on location(s) and quantity - please inquire

BRIDGE TOPS and MODESTY PANELS for MODULAR TABLES • LAMINATE and VENEER TOPS

Laminate tops with wood or COLORA edge feature 1/8" dia. vinyl inlay in COLORA between top surface and edge.

Specify: model number – top finish – edge profile and finish – inlay color (if applicable) – modesty finish

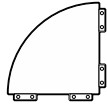

ITEM

DIMENSIONS

BRIDGE TOPS - Connector plates included

90-deg PIE

996-24	24" R x 24"
996-30	30" R x 30"
996-36	36" R x 36"

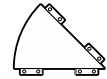

45-deg PIE

997-24	24" R x 24"
997-30	30" R x 30"
997-36	36" R x 36"

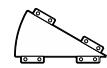

30-deg PIE

998-24	24" R x 24"
998-30	30" R x 30"
998-36	36" R x 36"



GANG SET

Each set \$80.00 factory installed.

Consists of two plates bolted to underside of adjacent tables and a linking bar and thumb screws. Gang Set connects and levels tables. Ganging 24", 30" and 36" sides requires 1 set. Ganging 42", 48", 60", 72", 90" sides and over requires 2 sets.

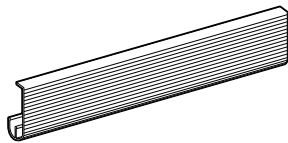

J MODESTY

Extruded aluminum modesty panel in ribbed pattern features a large wire management tray. 7 1/2" high. Removable without tools. Available in COLORA colors.

- Available with Fixed and Flip Top tables
- Folding Base tables – remove modesty prior to folding bases

	QTY1	QTY3	QTY10
48" L Tables	530	398	369
60" L Tables	534	437	407
72" L Tables	574	479	449
84" L Tables	614	519	489

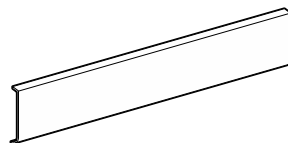

FLAT FOLDING MODESTY

Flat aluminum modesty panel is 9" high and folds over bases in folded position or over table underside with flip top option. Available in COLORA colors.

- Available with Flip Top and Folding Base tables. (Note: 48" L folding table not available with folding modesty)

	QTY1	QTY3	QTY10
48" L Tables	536	479	448
60" L Tables	640	577	548
72" L Tables	752	637	579

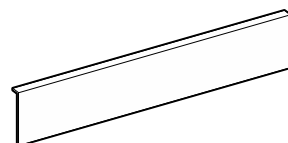

FLAT FIXED MODESTY

Flat aluminum modesty panel, 9" high. Available in COLORA colors.

Not recommended for flip top or folding base tables.

	QTY1	QTY3	QTY10
48" L Tables	308	272	246
60" L Tables	324	285	259
72" L Tables	394	356	330
84" L Tables	433	398	371

PLASTIC LAMINATE TOP

VENEER TOP



Flat Vinyl



Square Wood



Square Wood

Flat Vinyl			Square Wood			Square Wood		
QTY1	QTY3	QTY10	QTY1	QTY3	QTY10	QTY1	QTY3	QTY10

498	466	445	1075	917	813	984	877	813
543	505	480	1137	978	871	1041	935	871
611	569	539	1192	1034	960	1103	1001	926

473	443	421	1052	895	790	902	796	733
520	481	459	1114	955	849	939	831	770
587	545	516	1161	1003	888	983	876	812

461	429	407	1038	882	777	795	686	624
504	469	445	1098	941	832	805	697	635
571	527	499	1141	981	885	817	709	648

• Self Edge Laminate available at same price as Vinyl Edge.

MODULAR TABLE COLLECTION

Scale: 3/16" = 1'

RECTANGULAR TABLES



48" x 24"



60" x 24"



72" x 24"



84" x 24"



48" x 30"



60" x 30"



72" x 30"



84" x 30"



48" x 36"



60" x 36"



72" x 36"



84" x 36"

HALF ROUNDABLES



48" dia. x 24"



54" dia. x 27"

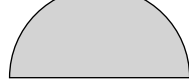

60" dia. x 30"



66" dia. x 33"



72" dia. x 36"

ARC TABLES

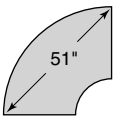

36"R x 24"d

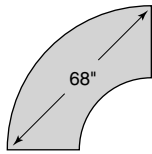

48"R x 24"d

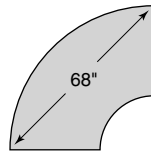

48"R x 30"d

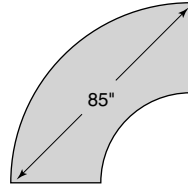

60"R x 30"d

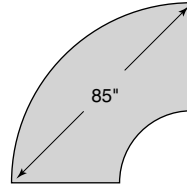

60"R x 36"d

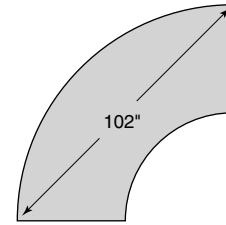

72"R x 36"d

TRAPEZOIDABLES

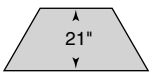

48" x 24" x 24"

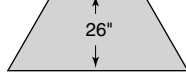

60" x 30" x 30"

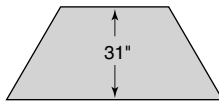

72" x 36" x 36"

V END TABLES

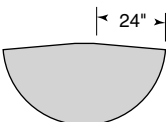

54" x 30"

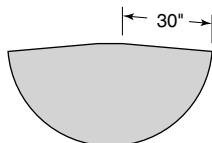

66" x 36"

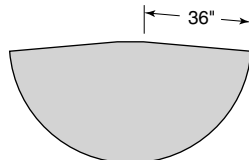

78" x 42"

QUARTER ROND TABLES & BRIDGE TOPS

90° Pie



24"R x 24"



30"R x 30"

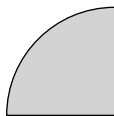

36"R x 36"

45° Pie



24"R x 24"



30"R x 30"



36"R x 36"

30° Pie



24"R x 24"



30"R x 30"



36"R x 36"



INFINITY TRAINING TABLES • C BASE

Tables are 29" high.

Specify: model number - p. lam. brand and number and vinyl edge color; or veneer finish - base color - options, see opposite below

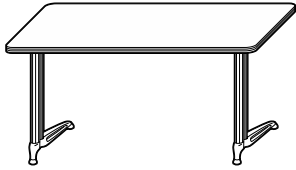

ITEM

DIMENSIONS

WITHOUT MODESTY PANEL

1791-4220	42" x 20"	
1791-4820	48" x 20"	
1791-6020	60" x 20"	
1791-7220	72" x 20"	
1791-4224	42" x 24"	C-Bases located 6" from end of table (non-folding only)
1791-4824	48" x 24"	
1791-6024	60" x 24"	
1791-7224	72" x 24"	
1791-4830	48" x 30"	
1791-6030	60" x 30"	
1791-7230	72" x 30"	

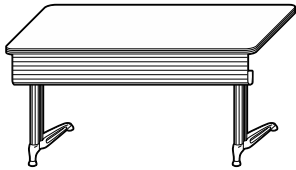

WITH J MODESTY PANEL (REMOVABLE)

Extruded aluminum modesty panel in ribbed pattern features a large wire management tray. 7 1/2' high. Removable (without tools) for folding base tables.

1792-4224	42" x 24"	
1792-4824	48" x 24"	
1792-6024	60" x 24"	C-Bases located 6" from end of table (non-folding only)
1792-7224	72" x 24"	
1792-4830	48" x 30"	
1792-6030	60" x 30"	
1792-7230	72" x 30"	

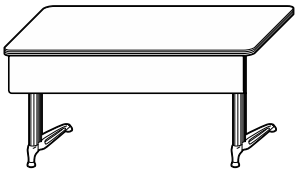

WITH FLAT FOLDING MODESTY PANEL

Utilized with Folding Base or Flip Top options - add cost. Flat aluminum modesty panel. 9" high. Folds over bases in folded position or over table underside with flip top option.

1794-6024	60" x 24"	
1794-7224	72" x 24"	
1794-6030	60" x 30"	C-Bases located 6" from end of table (non-folding only)
1794-7230	72" x 30"	

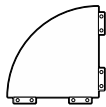

BRIDGE TOPS - Connector plates included

90-deg PIE

1780-20	20" R x 20"
1780-24	24" R x 24"
1780-30	30" R x 30"

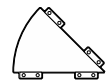

45-deg PIE

1782-20	20" R x 20"
1782-24	24" R x 24"
1782-30	30" R x 30"

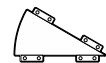

30-deg PIE

1783-20	20" R x 20"
1783-24	24" R x 24"
1783-30	30" R x 30"



GANG SET

Each set \$80.00 factory installed.

Consists of two plates bolted to underside of adjacent tables and a linking bar and thumb screws. Gang Set connects and levels tables. Ganging 24" and 30" sides requires 1 set.

PLASTIC LAMINATE TOP



Flat Vinyl Edge
QTY1 QTY3 QTY10

VENEER TOP



Reeded Wood Edge
QTY1 QTY3 QTY10

**ADD
 FOLDING
 BASE***

**ADD
 FLIP
 TOP**

1465	1418	1389	2448	2021	1898		
1478	1432	1402	2482	2055	1934		
1637	1580	1542	2722	2266	2141		
1808	1736	1691	2966	2478	2345		
1473	1425	1395	2493	2067	1944		569
1488	1440	1411	2528	2104	1982		569
1645	1587	1550	2780	2324	2198	471	569
1818	1746	1700	3036	2547	2414	471	569
1675	1613	1573	2772	2318	2193	0	569
1842	1766	1716	3077	2584	2448	471	569
2024	1935	1878	3407	2844	2703	471	569

1946	1804	1744	2964	2398	2291		569
1978	1835	1777	3020	2496	2346		569
2180	2023	1957	3313	2760	2604	471	569
2391	2220	2148	3610	3023	2864	471	569
2166	2010	1940	3265	2715	2559		569
2373	2203	2123	3611	3020	2854	471	569
2595	2412	2364	3979	3322	3153	471	569

2285	2164	2097	3420	2900	2745	471	569
2569	2382	2279	3788	3184	2994	471	569
2481	2342	2264	3717	3159	2994	471	569
2774	2571	2455	4157	3481	3282	471	569

473	445	426	912	805	744		
502	470	449	984	877	813		
543	505	480	1041	935	871		

449	421	402	834	725	664		
478	447	425	902	796	733		
520	481	459	939	831	770		

440	410	390	785	678	614		
466	434	412	795	686	624		
504	469	445	805	697	635		

- Standard Base is Fixed Height (Removable) with black Glides.
- Adjustable Height (Removable) Base: Add \$70.00 per Table.
- 3" diameter Infinity Lockable Casters: Add \$97.00 per T Base. Recommended for all Flip Top tables.
- Glides in COLORA colors: Add \$208.00
- *• 60" long folding tables have narrow range of suitable Surface Power Units based on location(s) and quantity - please inquire
- Table Cart: See page 9.



INFINITY TRAINING TABLES • T BASE

Tables are 29" high.

Specify: model number - p. lam. brand and number and vinyl edge color; or veneer finish - base color - options.

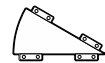
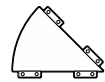
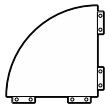
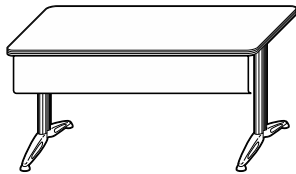
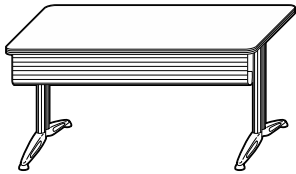

ITEM

DIMENSIONS

WITHOUT MODESTY PANEL

1735-4220	42" x 20"	
1735-4820	48" x 20"	
1735-6020	60" x 20"	
1735-7220	72" x 20"	
1735-4224	42" x 24"	T-Bases located 6" from end of table
1735-4824	48" x 24"	table (non-folding only)
1735-6024	60" x 24"	
1735-7224	72" x 24"	
1735-4830	48" x 30"	
1735-6030	60" x 30"	
1735-7230	72" x 30"	

WITH J MODESTY PANEL (REMOVABLE)

1736-4220	42" x 20"	
1736-4820	48" x 20"	
1736-6020	60" x 20"	
1736-7220	72" x 20"	
1736-4224	42" x 24"	T-Bases located 6" from end of table
1736-4824	48" x 24"	table (non-folding only)
1736-6024	60" x 24"	
1736-7224	72" x 24"	
1736-4830	48" x 30"	
1736-6030	60" x 30"	
1736-7230	72" x 30"	

WITH FLAT FOLDING MODESTY PANEL

Utilized with Folding Base or Flip Top options - add cost. Flat aluminum modesty panel features black plastic wire manager. 9" high. Folds over bases in folded position or over table underside with flip top option.

1738-6024	60" x 24"	
1738-7224	72" x 24"	T-Bases located 6" from end of table
1738-6030	60" x 30"	table (non-folding only)
1738-7230	72" x 30"	

BRIDGE TOPS - Connector plates included

90-deg PIE

1780-24	24" R x 24"
1780-30	30" R x 30"
1780-36	36" R x 36"

45-deg PIE

1782-24	24" R x 24"
1782-30	30" R x 30"
1782-36	36" R x 36"

30-deg PIE

1783-24	24" R x 24"
1783-30	30" R x 30"
1783-36	36" R x 36"

GANG SET

Each set \$96.00 factory installed.

Consists of two plates bolted to underside of adjacent tables and a linking bar and thumb screws. Gang Set connects and levels tables. Ganging 24" and 30" sides requires 1 set.

PLASTIC LAMINATE TOP



Flat Vinyl Edge

QTY1 QTY3 QTY10

VENEER TOP



Reeded Wood Edge

QTY1 QTY3 QTY10

ADD
FOLDING
BASE*

ADD
FLIP
TOP

1465	1418	1389	2448	2021	1898		569
1478	1432	1402	2482	2055	1934		569
1637	1580	1542	2722	2266	2141	471	569
1808	1736	1691	2966	2478	2345	471	569
1473	1425	1395	2493	2067	1944		569
1488	1440	1411	2528	2104	1982		569
1645	1587	1550	2780	2324	2198	471	569
1818	1746	1700	3036	2547	2414	471	569
1675	1613	1573	2772	2318	2193		569
1842	1766	1716	3077	2584	2448	471	569
2024	1935	1878	3407	2844	2703	471	569
1936	1793	1735	2919	2390	2244		569
1971	1826	1768	2974	2451	2301		569
2169	2016	1949	3253	2702	2547	471	569
2380	2215	2138	3540	2954	2793	471	569
1944	1802	1742	2964	2441	2291		569
1978	1835	1777	3020	2496	2346		569
2180	2023	1957	3313	2760	2604	471	569
2391	2222	2148	3610	3023	2864	471	569
2166	2010	1940	3265	2715	2559		569
2373	2203	2123	3611	3020	2854	471	569
2595	2412	2364	3979	3322	3153	471	569
2285	2164	2097	3420	2900	2745	471	569
2569	2382	2279	3788	3184	2994	471	569
2481	2342	2264	3717	3159	2994	471	569
2774	2571	2455	4157	3481	3282	471	569
473	445	426	912	805	744		
502	470	449	984	877	813		
563	525	500	1041	935	871		
449	421	402	834	725	664		
478	447	425	902	796	733		
539	501	479	939	831	770		
440	410	390	785	678	614		
466	434	412	795	686	624		
524	489	465	805	697	635		

- Standard Base is Fixed Height (Removable) with black Glides.
- Adjustable Height (Removable) Base: Add \$70.00 per Table.
- 3" diameter Infinity Lockable Casters: Add \$97.00 per T Base. Recommended for all Flip Top tables.
- Glides in COLORA colors: Add \$208.00
- *• 60" long folding tables have narrow range of suitable Surface Power Units based on location(s) and quantity - please inquire
- Table Cart: See page 9.



INFINITY MODULAR TABLES • T BASE

Tables are 29" high.

Specify: model number - p. lam. brand and number and vinyl edge color; or veneer finish - base color - options.

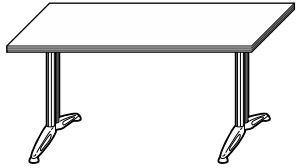

ITEM

DIMENSIONS

RECTANGLE

1762-4824	48" x 24"	
1762-6024	60" x 24"	
1762-7224	72" x 24"	
1762-9024	90" x 24"	
1762-4830	48" x 30"	
1762-6030	60" x 30"	T-Bases located 12" from end of table (non-folding only)
1762-7230	72" x 30"	
1762-9030	90" x 30"	
1762-4836	48" x 36"	
1762-6036	60" x 36"	
1762-7236	72" x 36"	
1762-9036	90" x 36"	
1762-4842	48" x 42"	
1762-6042	60" x 42"	
1762-7242	72" x 42"	
1762-9042	90" x 42"	
1762-6048	60" x 48"	
1762-7248	72" x 48"	
1762-9048	90" x 48"	

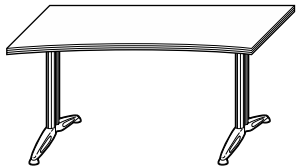

CONCAVE

1766-6030	60" x 30"	27 1/2" D	T-Bases located 12"
1766-7230	72" x 30"	26 1/2" D	from end of table
1766-7236	72" x 36"	32 1/2" D	(non-folding)

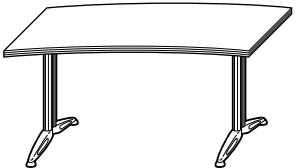

CONCAVE/CONVEX

1767-6030	60" x 32 1/2"	30" D	T-Bases located 12"
1767-7230	72" x 33 1/2"	30" D	from end of table
1767-7236	72" x 38 1/2"	36" D	(non-folding)

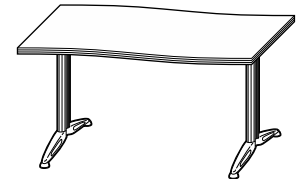

WAVE - DESCENDING

1768-6030	60" x 37"	30" D	T-Bases located 12"
1768-7230	72" x 42"	30" D	from end of table
1768-7236	72" x 48"	36" D	(non-folding)

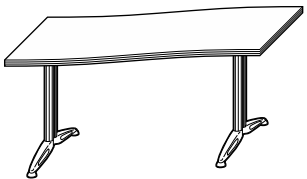

WAVE - ASCENDING

1769-6030	60" x 37"	30" D	T-Bases located 12"
1769-7230	72" x 42"	30" D	from end of table
1769-7236	72" x 48"	36" D	(non-folding)

PLASTIC LAMINATE TOP



Flat Vinyl Edge
 QTY1 QTY3 QTY10

VENEER TOP



Reeded Wood Edge
 QTY1 QTY3 QTY10

ADD
 FOLDING
 BASE*

ADD
 FLIP
 TOP

Flat Vinyl Edge QTY1	Reeded Wood Edge QTY3	QTY10	QTY1	QTY3	QTY10	ADD FOLDING BASE*	ADD FLIP TOP
1488	1440	1411	2528	2104	1982		569
1645	1587	1550	2780	2324	2198	471	569
1818	1746	1700	3036	2547	2414	471	569
2081	1999	1945	3415	2870	2734	471	946
1675	1613	1573	2772	2318	2193		569
1842	1766	1716	3077	2584	2448	471	569
2024	1935	1878	3407	2844	2703	471	569
2328	2224	2154	3835	3225	3074	471	946
1765	1694	1647	2974	2484	2353		569
1979	1889	1830	3350	2788	2646	471	569
2183	2075	2006	3670	3093	2946	471	569
2533	2405	2319	4317	3669	3461	471	946
1890	1807	1749	3195	2653	2516		579
2075	1976	1909	3627	3002	2851	471	579
2864	2736	2650	4484	4292	3647	471	640
3131	2983	2885	5090	4319	4099	471	946
2878	2750	2667	4399	3744	3593	471	579
3210	3061	2959	4877	4227	4022	471	640
4070	3869	3735	6160	5266	5085	471	946

2137	2057	2007	3438	2969	2749	471	569
2276	2185	2123	3706	3174	2932	471	569
2446	2335	2260	4025	3461	3221	471	569

2165	2137	2078	3566	3088	2865	471	569
2401	2294	2220	3706	3219	2994	471	569
2561	2437	2346	3835	3339	3112	471	569

2379	2279	2209	3720	3230	3006		579
2504	2391	2316	3827	3329	3058		640
2693	2560	2471	3969	3475	3242		640

2379	2279	2209	3720	3230	3006		579
2504	2391	2316	3827	3329	3058		640
2693	2560	2471	3969	3475	3242		640

- Standard Base is Fixed Height (Removable) with black Glides.
- Adjustable Height (Removable) Base: Add \$70.00 per Table.
- 3" diameter Infinity Lockable Casters: Add \$97.00 per T Base. Recommended for all Flip Top tables.
- Glides in COLORA colors: Add \$208.00
- * 60" long folding tables have narrow range of suitable Surface Power Units based on location(s) and quantity - please inquire
- Table Cart: See page 9.



INFINITY MODULAR TABLES • T BASE

Tables are 29" high.

Specify: model number - p. lam. brand and number and vinyl edge color; or veneer finish - base color - options.

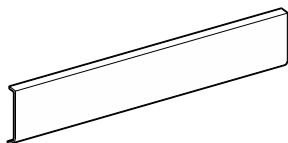
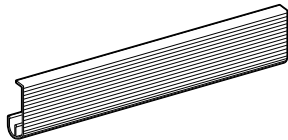
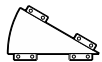
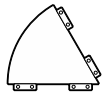
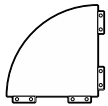
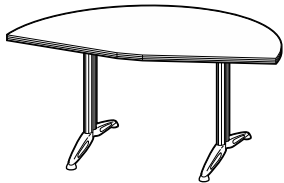
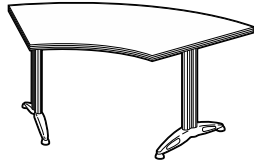
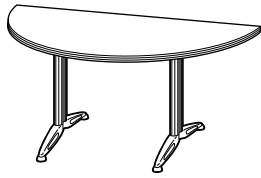

ITEM

DIMENSIONS

HALF ROUND

1763-48	48" dia x 24"
1763-60	60" dia x 30"
1763--72	72" dia x 36"

ARC

Overall Dim.

1764-60	60" x 33"	60" R 30" R
1764-90	90" x 36"	60" R 30" R

V END - Connector plates included

170-deg PIE

1765-24 (for 24" D Tables)	54" D x 30"
1765-30 (for 30" D Tables)	66" D x 36"
1765-36 (for 36" D Tables)	78" D x 42"

BRIDGE TOPS - Connector plates included

90-deg PIE

1780-24	24" R x 24"
1780-30	30" R x 30"
1780-36	36" R x 36"

60-deg PIE

1781-24	24" R x 24"
1781-30	30" R x 30"
1781-36	36" R x 36"

45-deg PIE

1782-24	24" R x 24"
1782-30	30" R x 30"
1782-36	36" R x 36"

GANG SET

Each set \$87.00 factory installed.

Consists of two plates bolted to underside of adjacent tables and a linking bar and thumb screws. Gang Set connects and levels tables. Ganging 24", 30" and 36" sides requires 1 set. Ganging 42", 48", 60", 72", 90" sides and over requires 2 sets.

J MODESTY

Extruded aluminum modesty panel in ribbed pattern features a large wire management tray. 7 1/2" high. Removable without tools. Available in COLORA colors.

- Also available with Flip Top tables
- Folding Base tables - remove modesty prior to folding bases.

	QTY1	QTY3	QTY10
48" L Tables	493	398	369
60" L Tables	535	438	409
72" L Tables	574	479	449
90" L Tables	711	598	564

FLAT FOLDING MODESTY

Flat aluminum modesty panel is 9" high, and folds over bases in folded position or over table underside with flip top option. Available in COLORA colors. Available with Flip Top and Folding Base tables.

	QTY1	QTY3	QTY10
48" L Tables	537	479	448
60" L Tables	641	577	548
72" L Tables	752	638	579

PLASTIC LAMINATE TOP

VENEER TOP



Flat Vinyl Edge



Reeded Wood Edge

**ADD
FLIP
TOP**

QTY1 QTY3 QTY10 QTY1 QTY3 QTY10

1808	1734	1683	3341	2809	2573	569
2248	2131	2055	3816	3253	2995	569
2826	2659	2551	4429	3833	3545	569
2369	2253	2176	4191	3563	3296	
2737	2594	2497	4869	4166	3888	
1980	1896	1840	3439	2896	2659	569
2307	2203	2130	3980	3409	3141	569
2700	2549	2450	4497	3880	3586	729
498	466	445	984	877	813	
543	505	480	1041	935	871	
611	569	539	1103	1001	926	
486	451	429	943	830	780	
530	494	472	981	887	812	
598	556	523	1062	941	857	
473	443	421	902	796	733	
520	481	459	939	831	770	
587	545	516	983	876	812	

INFINITY

- Standard Base is Fixed Height (Removable) with black Glides.
- Adjustable Height (Removable) Base: Add \$70.00 per Table.
- 3" diameter Infinity Lockable Casters: Add \$97.00 per T Base. Recommended for all Flip Top tables.
- Glides in COLORA colors: Add \$208.00
- Table Cart: See page 9.

COLUMN BASE TABLES • MODULAR • LAMINATE and VENEER TOPS

Laminate tops with wood or COLORA edge feature 1/8" dia. vinyl inlay in COLORA between top surface and edge. Column Base is 3" diameter. Standard base finish is COLORA colors; polished and satin chrome are available at upcharge. Tables are 29" high.

Specify: model number – top finish – edge profile and finish – inlay color (if applicable) – base finish – optional modesty finish – options.

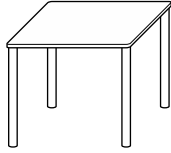

ITEM DIMENSIONS

SQUARE

972-30	30" x 30"
972-36	36" x 36"
972-42	42" x 42"
972-48	48" x 48"

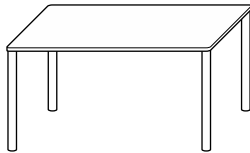

RECTANGLE

973-4824	48" x 24"
973-6024	60" x 24"
973-7224	72" x 24"
973-4830	48" x 30"
973-6030	60" x 30"
973-7230	72" x 30"
973-6036	60" x 36"
973-7236	72" x 36"

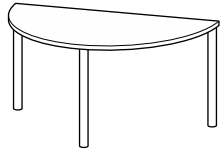
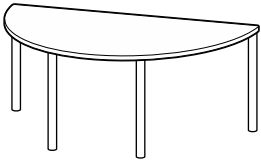

HALF ROUND

974-48	48" dia. x 24"
974-54	54" dia. x 27"
974-60-3	60" dia. x 30"
974-60-4	60" dia. x 30"
974-66	66" dia. x 33"
974-72	72" dia. x 36"

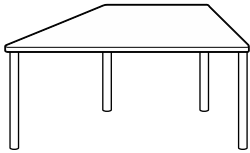

TRAPEZOID

976-4824	48" x 24" x 24"
976-6030	60" x 30" x 30"
976-7236	72" x 36" x 36"

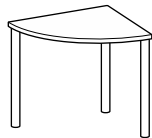

QUARTER ROUND

977-24	24" R x 24"
977-30	30" R x 30"
977-36	36" R x 36"

PLASTIC LAMINATE TOP

VENEER TOP



Flat Vinyl



Square Wood



Square Wood

**ADD POL
or SATIN
CHROME**

QTY1	QTY3	QTY10	QTY1	QTY3	QTY10	QTY1	QTY3	QTY10	
821	786	762	1663	1358	1202	1883	1488	1364	161
962	909	876	1855	1528	1355	2202	1755	1621	161
1146	1075	1029	2074	1720	1525	2546	2041	1900	161
1413	1322	1259	2400	2017	1799	2988	2433	2281	161
909	864	833	1809	1487	1315	2074	1647	1525	161
1093	1036	999	2048	1705	1520	2371	1916	1789	161
1216	1143	1097	2225	1861	1658	2598	2108	1975	161
1049	987	946	1967	1626	1444	2280	1824	1698	161
1240	1166	1116	2215	1854	1656	2629	2136	1998	161
1371	1282	1224	2400	2017	1801	2926	2367	2225	161
1379	1287	1229	2376	1995	1782	2913	2350	2208	161
1527	1422	1352	2574	2172	1941	3243	2623	2477	161
1069	995	944	2137	1774	1569	2601	2067	1833	161
1251	1157	1094	2342	1962	1735	2771	2229	1989	161
1545	1430	1352	2659	2257	2010	3113	2550	2293	123
1713	1598	1520	2825	2424	2175	3280	2719	2461	161
1943	1802	1710	3069	2644	2375	3490	2919	2649	161
2156	1990	1881	3329	2879	2588	3793	3196	2907	161
1110	1044	1000	1988	1645	1462	2120	1687	1556	161
1582	1474	1404	2504	2109	1889	2689	2186	2039	161
2017	1867	1768	2977	2534	2275	3348	2717	2560	161
698	665	642	1716	1396	1207	2149	1701	1436	123
767	725	698	1847	1510	1307	2447	1942	1667	123
930	871	831	2087	1714	1487	2741	2214	1909	123

COLUMN

- Self Edge Laminate available at same price as Vinyl Edge.
- Black Lockable Casters (3" dia.): \$99.00 per table.
- Option: Infinity Lockable Casters: \$223.00 per table.
- Standing Height, 40" or 42": \$168.00
- Bridge Tops and optional Modesty Panels: see page 158.

FOLDING COLUMN BASE TABLES

Laminate tops with wood edge feature 1/8" dia. vinyl inlay in COLORA between top surface and edge.

4" DIA. FOLDING COLUMN BASE TABLES

4" dia. Column bases in COLORA colors or optional chrome finishes. Bases are folding. Specify TVA Cart for table storage and transport. Tables are 29" high.

Specify: model number – top finish – edge profile and finish – inlay color (if applicable) – base color - options.

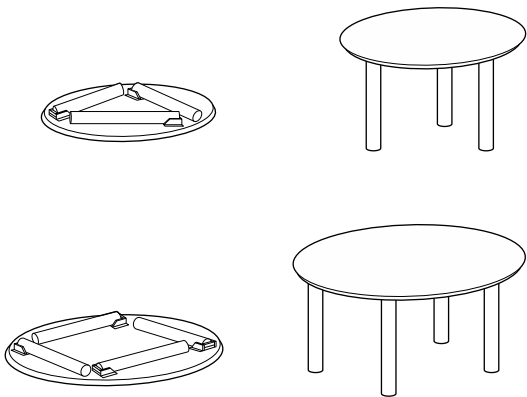

ITEM	DIMENSIONS
------	------------

971-48	48" dia.
--------	----------

971-54	54" dia.
--------	----------

971-60	60" dia.
--------	----------

971-72 (Top with center seam)	72" dia.
-------------------------------	----------

PLASTIC LAMINATE TOP

							
	Flat Vinyl		Square Wood				
QTY1	QTY3	QTY10	QTY1	QTY3	QTY10		ADD POL or SATIN CHROME

2236	2141	2078	3408	3041	2741		201
------	------	------	------	------	------	--	-----

2942	2821	2744	4174	3792	3447		267
3365	3197	3085	4714	4287	3878		267
4612	4319	4125	5937	5356	4835		267

- Black Lockable Casters (3" dia.): \$99.00 per table. Always recommended for Flip Top tables.
- Option: Infinity Lockable Casters: \$223.00 per table.

PARSONS BASE TABLES • VIDRO PAINTED BACK GLASS

See standard color choices. Customer's own color must be pre-approved through custom quotation.

Bases 2" x 2" Steel (COLORA) and Stainless Steel (Polished or Brushed). Tops have RB edge profile resulting in 1 1/2" overhang. Tables are 29" high.

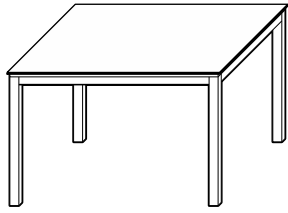

ITEM

DIMENSIONS

SQUARE

220V-4848	48" x 48" x 29" H
220V-5454	54" x 54" x 29" H
220V-6060	60" x 60" x 29" H
220V-8080 (Top in 2 sections)	80" x 80" x 29" H
220V-9090 (Top in 2 sections)	90" x 90" x 29" H

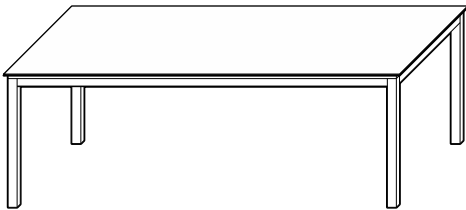

RECTANGLE

220V-7236	72" x 36" x 29" H
220V-8442	84" x 42" x 29" H
220V-9648	96" x 48" x 29" H
220V-1084 (Top in 2 sections)	108" x 48" x 29" H
220V-1204 (Top in 2 sections)	120" x 48" x 29" H
220V-1206 (Top in 2 sections)	120" x 60" x 29" H

- All tables include four vertical bases located at corners. Base verticals do not offer internal wire management option.

PAINTED BACK GLASS TOP (CL GLASS)

MATTE (MA GLASS)

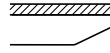
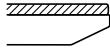

1 1/4" RB
QTY1 QTY3

1 1/4" RB
QTY1 QTY3

**ADD
CRATE
NET \$**

**ADD
POL
STAIN**

**ADD
BRUSH
STAIN**

6066	5636	7155	6676	153	3156	1440
7292	6860	8651	8169	172	3326	1567
8484	8055	10123	9644	191	3494	1692
14100	13118			416	3824	2116
16463	15481			458	4092	2337
7231	6800	8541	8061	208	3331	1577
9097	8646	10782	10282	243	3649	1811
10747	10298	12861	12362	277	3660	2030
11609	11049	13962	13353	312	3856	2185
13826	12845	16662	15535	347	4006	2291
15457	14474	18830	17703	382	4273	2515

• Top RB edge profile (overhang)

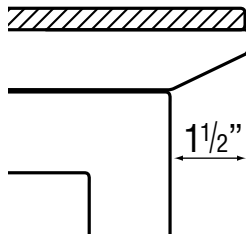

• Vidro Art option require additional details - custom quote required.

CARTS • LECTERNS

Specify: model number - case finish - options such as door pulls, locks, stone for Serving Carts, UTP Power Unit and Light for the Lecterns, etc.

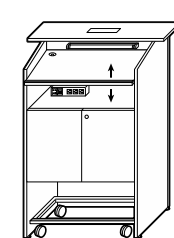
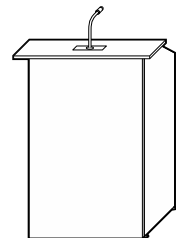
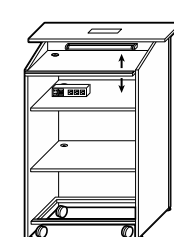
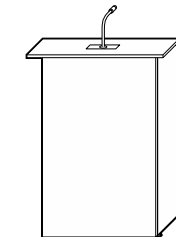
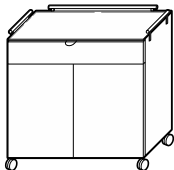
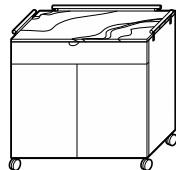
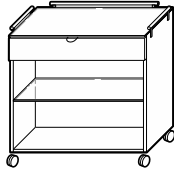
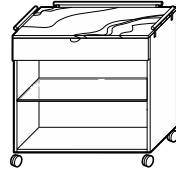
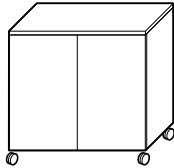
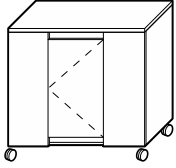
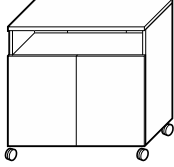
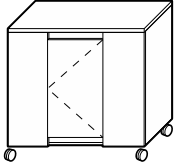
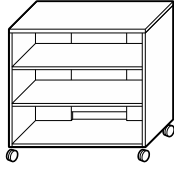
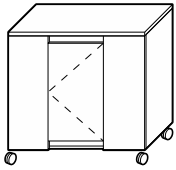

ITEM

DIMENSIONS

AV • COMPUTER CART

2030

34" x 22" x 36"H

Accommodates multimedia equipment. Two adjustable shelves with grommets and hinged rear access door allow wire access and management. 3" dia. locking casters.

AV • COMPUTER CART

2033

34" x 22" x 36"H

Features open shelf with backside grommet for wire access into cabinet, an adjustable shelf behind doors and hinged rear access door.

AV CART

2034

34" x 22" x 36"H

Two adjustable shelves with grommets behind doors and hinged rear access door. 3" dia. locking casters.

Additional Shelf: Colora, \$175.00 ; Veneer, \$230.00

SERVING CART

2050

34" x 22" x 36"H

Divided top drawer and open cabinet with adjustable 3/8" clear glass shelf. Serving surface is 3/8" clear glass or optional stone. Handle and guard bars in COLORA colors. 3" dia. locking casters.

Marble or Granite Top Surface, add \$998.00

Additional 3/8" clear glass shelf, \$362.00

SERVING CART

2051

34" x 22" x 36"H

Divided top drawer and double doors with adjustable shelf inside. Serving surface is 3/8" clear glass or optional stone. Handle and guard bars in COLORA colors. 3" dia. locking casters.

Marble or Granite Top Surface, add \$998.00

Additional Shelf: Colora, \$175.00 ; Veneer, \$230.00

LECTERN

2060

34" x 26" x 48"H

Case:

28" x 24"

Straight top surface, 36" x 12", can accommodate a laptop and is equipped with a removable aluminum plate for customer supplied microphone. Work surface, 28" x 19", is angle-adjustable with paper stop and grommet. Two adjustable shelves with grommets, non-marking foot rest, 3" dia. locking casters are provided.

Reading Light, \$483.00 • UTP Power and Presentation Unit, see pages 10 and 11.

LECTERN

2061

34" x 26" x 48"H

Case:

28" x 24"

Straight top surface, 36" x 12", can accommodate a laptop and is equipped with a removable aluminum plate for customer supplied microphone. Work surface, 28" x 19", is angle-adjustable with paper stop and grommet. Two-door cabinet with grommets for internal wiring, non-marking foot rest, 3" dia. locking casters are provided.

Reading Light, \$483.00 • UTP Power and Presentation Unit, see pages 10 and 11.

Door Lock, \$139.00

COLORA QTY1	QTY3	VENEER QTY1	QTY3
2411	2007	5277	4583
2809	2321	5924	5133
2825	2340	5988	5197
3282	2904	5924	5332
3681	3238	6541	5883
2837	2310	4454	3706
3397	2614	5166	4321

CONSOLE / SERVER • VISUAL BOARDS

Specify: model number - top, panel, edge finish and profile for Console/Servers; case and door or frame finish for Visual and Marker Board - optional Marker Board accessories.



ITEM

DIMENSIONS

PANEL CONSOLE / SERVER

2024-4829	48" x 20" x 29"H
2024-4834	48" x 20" x 34"H
2024-6029	60" x 20" x 29"H
2024-6034	60" x 20" x 34"H
2024-7229	72" x 20" x 29"H
2024-7234	72" x 20" x 34"H

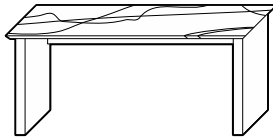

PANEL CONSOLE / SERVER • STONE TOP

2024M-4829	48" x 20" x 29"H
2024M-4834	48" x 20" x 34"H
2024M-6029	60" x 20" x 29"H
2024M-6034	60" x 20" x 34"H
2024M-7229	72" x 20" x 29"H
2024M-7234	72" x 20" x 34"H

P. LAM or COLORA TOP • SPECIFY EDGE

COLORA PANELS		VENEER PANELS	
QTY1	QTY3	QTY1	QTY3
1975	1505	3215	2615
2011	1538	3383	2785
2057	1587	3369	2771
2092	1621	3536	2941
2138	1667	3523	2925
2173	1703	3692	3094

VENEER TOP • SPECIFY EDGE

VENEER PANELS	
QTY1	QTY3
3880	3281
4050	3450
4111	3645
4279	3812
4339	3859
4508	4028

MARBLE OR GRANITE TOP

3/4" RB or 3/4" BN EDGE

COLORA PANELS		VENEER PANELS	
QTY1	QTY3	QTY1	QTY3
3819	3606	5055	4718
3852	3643	5223	4887
4484	4273	5794	5459
4517	4308	5964	5626
5147	4939	6532	6198
5184	4974	6702	6300

MARBLE OR GRANITE TOP

1 1/2" RB or BN or SQ EDGE

COLORA PANELS		VENEER PANELS	
QTY1	QTY3	QTY1	QTY3
5387	5178	6625	6289
5422	5212	6795	6456
6287	6076	7598	7260
6320	6112	7765	7431
7183	6976	8568	8234
7220	7009	8738	8402

FINISHES - TABLE TOPS

Colora

COLORA is a textured polyurethane material applied to MDF board in two steps. It is scratch-resistant and stain proof. Although highly durable, COLORA surfaces are not as hard as laminates. It is applied to table tops and edges. COLORA is available in 15 standard colors. Custom color charge is \$350.00 NET per color mix.

Wood Veneers, Wood Edges

Veneer tops and hardwood edges are flat cut species of Maple, Cherry and Walnut offered in numerous stains. Custom stain charge is \$350.00 NET for set-up and \$50.00 NET per unit. Prismatic offers all regular and premium veneers which are readily available – please inquire for pricing. Veneered surfaces are semi-open and finished in a low-medium sheen and clear catalyzed lacquer.

Glass

Light scratches, waves or tiny bubbles are inherent to glass fabrication and to be expected. Prismatic offers 1/2” or 3/4” thick glass tops which are clear or sandblasted. Also painted back glass (PBG) consisting of 1/4” starphire glass silicone adhered to 1” thick MDF subtop. Available with clear and matte glass types.

Stone

See standard marble and granite varieties. Prismatic will make available most stones specified by customer, often at no up-charge. Stone surfaces vary greatly in color, texture, pattern and quality. Marble in particular is seldom free of fine cracks or other imperfections. All stone surfaces have natural polish.

FINISHES - BASE METAL PRODUCTS

Occasional table bases and metal drums are made of high grade steel, buffed and plated or sprayed in COLORA colors.

Plated finishes include polished or satin chrome.

Metal cube tables are stainless steel sheets applied to wood cores. Metal drums are available in stainless steel for quantity orders.

Custom COLORA charge is NET \$350.00 per match.

TABLE TOP - EDGE CONFIGURATIONS

COLORA and Wood Veneer Tops , 3/4” Thick



3/4” SQUARE EDGE (SE)
 • COLORA Top and Edge
 • Veneer Top and Edge
Ronde, Piato and 200 Parsons Tables

Stone Tops, 3/4” Thick



SQUARE EDGE (SE)
Ronde, 200 Parsons, 500M, 550M, 700M, 750M Drum and Cube Tables

Glass Tops, 1/2” or 3/4” Thick

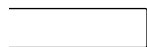

STRAIGHT EDGE (SE)
 (Slight Chamfer)
 • 1/2” or 3/4” Thick
 • Clear or Sandblast
Ronde, Piato, 200 Parsons, 500G, 550G, 700G, 750G, Drum and Cube Tables

Painted Back Glass Tops, 1 1/4” Thick

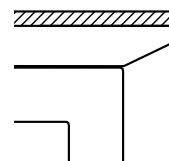

REVERSE BEVEL EDGE (RB)
 (Overhang)
Ronde, 200 Parsons, Piato, Drum and Cube Tables

PIATO TABLES • GLASS TOP

Welded steel COLORA bases with 2" column either offset (end tables) or centered (coffee and end tables) with clear (CL), tempered glass tops and 1/2" thick finished round plate bases. Optional colored glass in either painted back glass (PBG) clear or painted back glass matte (MA) in any standard COLORA color (custom color available at upcharge).

Specify: model number - base finish - glass type

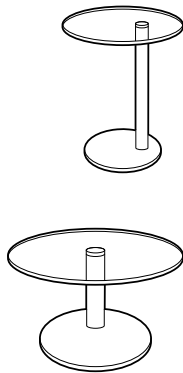

ITEM	DIMENSIONS
160-1822	18" dia x 22" H
160-1825	18" dia x 25" H
160-2022	20" dia x 22" H
160-2025	20" dia x 25" H
160-2416	24" dia x 16" H
160-2422	24" dia x 22" H
160-2425	24" dia x 25" H
160-3016	30" dia x 16" H
160-3022	30" dia x 22" H
160-3025	30" dia x 25" H
160-3616	36" dia x 16" H
160-3622	36" dia x 22" H
160-3625	36" dia x 25" H
160-4216	42" dia x 16" H
160-4222	42" dia x 22" H
160-4225	42" dia x 25" H
160-4816	48" dia x 16" H
160-4822	48" dia x 22" H
160-4825	48" dia x 25" H

PIATO TABLES • STONE TOP

Welded steel COLORA bases with 2" column either offset (end tables) or centered (coffee and end tables) with either square edge (SQ) or reverse bevel edge (RB) stone tops. See standard options. Custom options to match customers own stone available at an upcharge.

Specify: model number - base finish - stone type

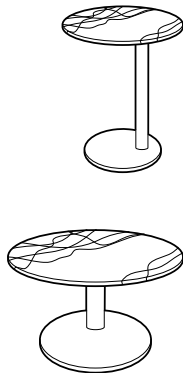

ITEM	DIMENSIONS
160M-1822	18" dia x 22" H
160M-1825	18" dia x 25" H
160M-2022	20" dia x 22" H
160M-2025	20" dia x 25" H
160M-2416	24" dia x 16" H
160M-2422	24" dia x 22" H
160M-2425	24" dia x 25" H
160M-3016	30" dia x 16" H
160M-3022	30" dia x 22" H
160M-3025	30" dia x 25" H
160M-3616	36" dia x 16" H
160M-3622	36" dia x 22" H
160M-3625	36" dia x 25" H
160M-4216	42" dia x 16" H
160M-4222	42" dia x 22" H
160M-4225	42" dia x 25" H
160M-4816	48" dia x 16" H
160M-4822	48" dia x 22" H
160M-4825	48" dia x 25" H

1/2" CL GLASS TOP			3/4" CL GLASS TOP			CL ADD CRATE NET \$	1 1/4" PBG (CL) GLASS TOP			1 1/4" PBG (MA) GLASS TOP			PBG ADD CRATE NET \$	ADD SATIN CHROME	ADD POL CHROME
COLORA BASE QTY1	QTY3	QTY10	COLORA BASE QTY1	QTY3	QTY10		COLORA BASE QTY1	QTY3	QTY10	COLORA BASE QTY1	QTY3	QTY10			
1190	1088	964	1391	1290	1165	18	1652	1436	1265	1910	1669	1489	24	148	316
1190	1088	964	1391	1290	1165	18	1652	1436	1265	1910	1669	1489	24	148	316
1242	1141	1017	1478	1375	1252	22	1705	1490	1319	1996	1757	1575	30	148	316
1242	1141	1017	1478	1375	1252	22	1705	1490	1319	1996	1757	1575	30	148	316
1489	1386	1263	1846	1744	1621	32	1941	1726	1556	2307	2067	1885	43	148	316
1600	1496	1374	1957	1855	1732	32	2051	1836	1666	2417	2180	1996	43	148	316
1612	1510	1386	1969	1867	1744	32	2064	1848	1679	2430	2191	2009	43	148	316
1757	1654	1531	2316	2213	2089	66	2384	2169	1932	2847	2609	2347	95	171	401
1867	1764	1641	2426	2323	2199	66	2494	2280	2042	2957	2719	2459	95	171	401
1880	1777	1654	2439	2336	2213	66	2507	2292	2055	2970	2731	2470	95	171	401
							2992	2776	2540	3614	3373	3113	114	227	478
							3102	2888	2650	3725	3483	3223	114	227	478
							3116	2900	2664	3736	3496	3237	114	227	478
							3864	3649	3413	4706	4466	4206	134	244	556
							3975	3759	3523	4817	4579	4316	134	244	556
							3987	3772	3535	4831	4591	4329	134	244	556
							4960	4572	4314	6066	5628	5345	153	322	696
							5071	4682	4425	6177	5739	5458	153	322	696
							5085	4694	4437	6190	5751	5469	153	322	696

3/4" SQ GRANITE OR MARBLE TOP			3/4" RB GRANITE OR MARBLE TOP			ADD CRATE NET \$	ADD SATIN CHROME	ADD POL CHROME
COLORA BASE QTY1	QTY3	QTY10	COLORA BASE QTY1	QTY3	QTY10			
1614	1411	1248	2444	2240	2076	24	148	316
1614	1411	1248	2444	2240	2076	24	148	316
1758	1555	1390	2680	2477	2314	30	148	316
1758	1555	1390	2680	2477	2314	30	148	316
2200	1997	1834	3308	3105	2942	43	148	316
2313	2108	1944	3420	3216	3052	43	148	316
2324	2120	1957	3432	3228	3065	43	148	316
2919	2715	2550	4303	4099	3934	95	171	401
3029	2825	2662	4413	4209	4046	95	171	401
3042	2838	2675	4426	4222	4058	95	171	401
4276	4133	3970	5937	5794	5631	114	227	478
4386	4245	4080	6047	5905	5741	114	227	478
4399	4257	4094	6060	5917	5755	114	227	478
4970	4768	4602	6907	6705	6540	134	244	556
5081	4879	4713	7020	6817	6650	134	244	556
5093	4891	4726	7032	6829	6663	134	244	556
6365	6121	5876	8579	8336	8090	153	322	696
6475	6233	5987	8689	8446	8202	153	322	696
6488	6245	5999	8703	8459	8214	153	322	696

OCCASIONAL

• Crating charges per top. Crating for Qty: 4+ will be quoted.

PIATO TABLES • VENEER TOP

Welded steel COLORA bases with 2" column either offset (end tables) or centered (coffee and end tables) with square edge (SQ) veneer tops. See standard options. Custom options to match customers own veneer available at an upcharge.

Specify: model number - base finish - veneer type

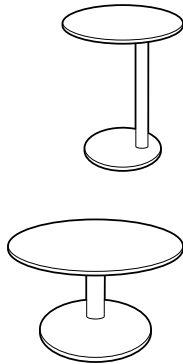

ITEM	DIMENSIONS	
160W-1822	18" dia x 22" H	24
160W-1825	18" dia x 25" H	24
160W-2022	20" dia x 22" H	30
160W-2025	20" dia x 25" H	30
160W-2416	24" dia x 16" H	43
160W-2422	24" dia x 22" H	43
160W-2425	24" dia x 25" H	43
160W-3016	30" dia x 16" H	95
160W-3022	30" dia x 22" H	95
160W-3025	30" dia x 25" H	95
160W-3616	36" dia x 16" H	114
160W-3622	36" dia x 22" H	114
160W-3625	36" dia x 25" H	114
160W-4216	42" dia x 16" H	134
160W-4222	42" dia x 22" H	134
160W-4225	42" dia x 25" H	134
160W-4816	48" dia x 16" H	153
160W-4822	48" dia x 22" H	153
160W-4825	48" dia x 25" H	153

3/4" SQ VENEER TOP

COLORA BASE			ADD	ADD
QTY1	QTY3	QTY10	SATIN	POL
			CHROME	CHROME
1443	1052	801	148	316
1443	1052	801	148	316
1465	1074	842	148	316
1465	1074	842	148	316
2651	1921	1622	148	316
2763	2033	1733	148	316
2775	2044	1745	148	316
3011	2242	1918	171	401
3121	2353	2029	171	401
3133	2367	2041	171	401
3539	2926	2518	227	478
3649	3038	2628	227	478
3661	3050	2642	227	478
4096	3460	3023	244	556
4207	3571	3133	244	556
4220	3583	3146	244	556
4758	4056	3570	322	696
4871	4168	3680	322	696
4881	4180	3693	322	696

OCCASIONAL

• QTY 1 shipments subject to extra packaging charges to be quoted.

RONDE TABLES • GLASS TOP

Welded solid barstock steel base in plated finishes and COLORA colors. 1/2" clear or sandblast glass tops.

Custom sizes available for quantity orders only.

Specify: model number - base finish - glass type

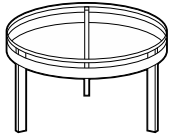

ITEM	DIMENSIONS
170-2021	20" dia x 21" H
170-2421	24" dia x 21" H
170-3016	30" dia x 16" H
170-3616	36" dia x 16" H
170-4216	42" dia x 16" H

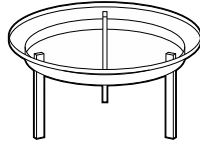

OVERHANG GLASS	
170-2421-OH	24" dia x 21" H
170-3616-OH	36" dia x 16" H
170-4216-OH	42" dia x 16" H

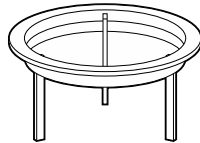

OVERHANG GLASS SANDBLAST BORDER	
170-2421-SB	24" dia x 21" H (2" Border)
170-3616-SB	36" dia x 16" H (3" Border)
170-4216-SB	42" dia x 16" H (3" Border)

RONDE TABLES • STONE TOP

Welded solid barstock steel base in plated finishes and COLORA colors. Stone tops with **Square** edge.

Custom sizes available for quantity orders only.

Specify: model number - base finish - stone type

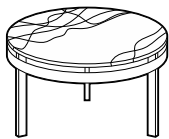

ITEM	DIMENSIONS
170M-2021	20" dia x 21" H
170M-2421	24" dia x 21" H
170M-3016	30" dia x 16" H
170M-3616	36" dia x 16" H
170M-4216	42" dia x 16" H

RONDE TABLES • COLORA and WOOD TOP

Welded solid barstock steel frame in all standard COLORA colors. COLORA or veneer tops with **Square** self edge.

Specify: model number - metal finish - Colora color or veneer top

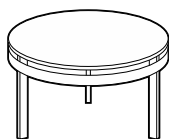

ITEM	DIMENSIONS
FLUSH TOP • SQUARE EDGE	
170W-2021	20" dia x 21" H
170W-2421	24" dia x 21" H
170W-3016	30" dia x 16" H
170W-3616	36" dia x 16" H
170W-4216	42" dia x 16" H

1/2" GLASS TOP			1/2" SANDBLAST GLASS TOP			ADD CRATE NET \$	ADD SATIN + POL CHROME
COLORA BASE			COLORA BASE				
QTY1	QTY3	QTY10	QTY1	QTY3	QTY10		
1093	1041	986	1119	1067	1014	22	501
1228	1159	1121	1285	1234	1179	32	537
1463	1410	1356	1577	1522	1469	66	537
2233	2181	2033	2400	2348	2199	80	778
2830	2779	2627	3054	3003	2851	94	972
1152	1098	1048	1227	1175	1119	32	501
1658	1606	1554	1824	1771	1719	80	547
2466	2413	2265	2691	2639	2490	94	778
1337	1285	1231				32	501
2039	1985	1933				80	537
2909	2855	2710				94	778
MARBLE OR GRANITE TOP							
COLORA BASE							
QTY1	QTY3	QTY10					
1862	1810	1759				30	501
2343	2291	2240				43	537
3304	3254	2967				95	537
4596	4515	4411				114	778
6061	6011	5855				134	972
COLORA TOP			WOOD VENEER TOP				
COLORA BASE			COLORA BASE				
QTY1	QTY3	QTY10	QTY1	QTY3	QTY10		
1207	1038	941	1371	1190	1056	417	501
1256	1175	985	1488	1293	1133	448	537
1512	1283	1151	1767	1554	1358	448	537
2193	1911	1687	2577	2158	1974	649	778
2634	2340	2104	3139	2868	2478	810	972

• Crating charges per top. Crating for Qty: 4+ will be quoted.
 • QTY 1 shipments subject to extra packaging charges to be quoted.

OCCASIONAL

210 PARSONS TABLES • GLASS, COLORA, WOOD TOP

1" square stainless steel frame. 1/2" or 3/4" clear or sandblast glass and 3/4" COLORA or veneer tops are flush with base.

Specify: model number - base finish - glass type and thickness or Colora color or veneer type

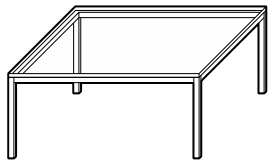

ITEM

DIMENSIONS

210-3030	30" x 30" x 16" H
210-3636	36" x 36" x 16" H
210-4242	42" x 42" x 16" H
210-4024	40" x 24" x 16" H
210-4626	46" x 26" x 16" H
210-4830	48" x 30" x 16" H
210-4848	48" x 48" x 16" H

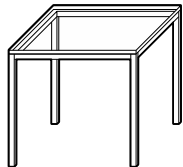

210-1822	18" x 18" x 22" H
210-2022	20" x 20" x 22" H
210-2422	24" x 24" x 22" H
210-3022	30" x 30" x 22" H

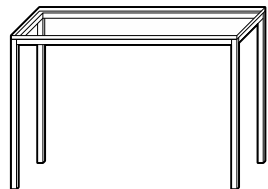

210-4215	42" x 15" x 29" H
210-4815	48" x 15" x 29" H

210 PARSONS TABLES • STONE TOP

1" square stainless steel frame. Marble or granite tops are **Square** edge and flush with base.

Specify: model number - base finish - marble or granite variety

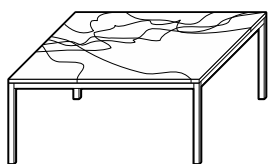

ITEM

DIMENSIONS

210M-3030	30" x 30" x 16" H
210M-3636	36" x 36" x 16" H
210M-4242	42" x 42" x 16" H
210M-4024	40" x 24" x 16" H
210M-4626	46" x 26" x 16" H
210M-4830	48" x 30" x 16" H
210M-4848	48" x 48" x 16" H

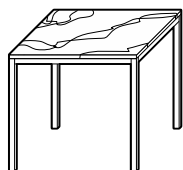

210M-1822	18" x 18" x 22" H
210M-2022	20" x 20" x 22" H
210M-2422	24" x 24" x 22" H
210M-3022	30" x 30" x 22" H

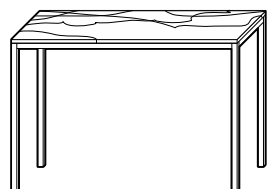

210M-4215	42" x 15" x 29" H
210M-4815	48" x 15" x 29" H

1/2" GLASS or COLORA TOP			3/4" GLASS or VENEER TOP			GLASS ADD CRATE NET \$	ADD SANDBLAST	ADD BRUSH STAIN	ADD POL STAIN
COLORA BASE QTY1	QTY3	QTY10	COLORA BASE QTY1	QTY3	QTY10				
1463	1390	1317	1866	1773	1680	66	110	374	769
1656	1572	1491	2226	2116	2004	80	160	411	828
1989	1890	1790	2767	2627	2490	94	218	425	948
1504	1428	1355	1922	1828	1731	51	120	387	772
1615	1535	1455	2142	2035	1929	64	147	411	828
1888	1793	1698	2563	2436	2307	77	191	424	898
2227	2117	2005	3241	3078	2918	107	282	598	1045
1240	1179	1117	1414	1344	1274	18	42	278	586
1251	1187	1127	1425	1353	1282	22	51	311	622
1337	1270	1204	1591	1512	1434	32	71	329	724
1495	1422	1346	1894	1799	1705	66	110	411	828
1512	1437	1361	1920	1824	1730	36	82	489	933
1559	1481	1403	2004	1903	1803	40	95	524	960

MARBLE or GRANITE TOP			ADD CRATE NET \$	ADD BRUSH STAIN	ADD POL STAIN
COLORA BASE QTY1	QTY3	QTY10			
3033	2941	2772	95	374	769
3936	3846	3679	114	411	828
5112	5021	4853	134	425	948
3173	3079	2914	73	387	772
3715	3623	3456	91	411	828
4596	4504	4339	110	424	898
5915	5811	5615	153	598	1045
1729	1641	1556	24	278	586
1907	1813	1716	30	311	622
2314	2220	2053	43	329	724
3058	2964	2799	95	411	828
2600	2470	2341	48	489	933
2761	2623	2486	54	524	960

• Crating charges per top. Crating for Qty: 4+ will be quoted.

OCCASIONAL

212 DOUBLE BAR PARSONS TABLES • GLASS, COLORA, WOOD TOP

1" square stainless steel frame. 1/2" or 3/4" clear or sandblast glass and 3/4" COLORA or veneer tops are flush with base.

Specify: model number - base finish - glass type and thickness or Colora color or veneer type

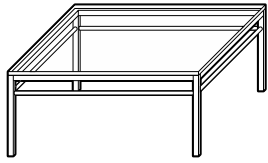

ITEM	DIMENSIONS
212-3030	30" x 30" x 16" H
212-3636	36" x 36" x 16" H
212-4242	42" x 42" x 16" H
212-4024	40" x 24" x 16" H
212-4626	46" x 26" x 16" H
212-4830	48" x 30" x 16" H
212-4848	48" x 48" x 16" H

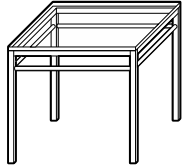

212-1822	18" x 18" x 22" H
212-2022	20" x 20" x 22" H
212-2422	24" x 24" x 22" H
212-3022	30" x 30" x 22" H

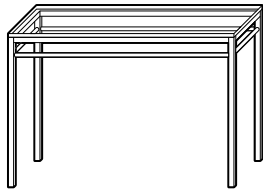

212-4215	42" x 15" x 29" H
212-4815	48" x 15" x 29" H

212 DOUBLE BAR PARSONS TABLES • STONE TOP

1" square stainless steel frame. Marble or granite tops are **Square** edge and flush with base.

Specify: model number - base finish - marble or granite variety

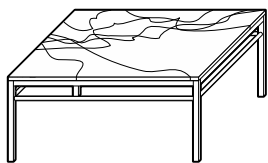

ITEM	DIMENSIONS
212M-3030	30" x 30" x 16" H
212M-3636	36" x 36" x 16" H
212M-4242	42" x 42" x 16" H
212M-4024	40" x 24" x 16" H
212M-4626	46" x 26" x 16" H
212M-4830	48" x 30" x 16" H
212M-4848	48" x 48" x 16" H

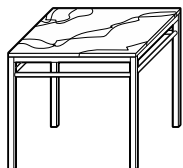

212M-1822	18" x 18" x 22" H
212M-2022	20" x 20" x 22" H
212M-2422	24" x 24" x 22" H
212M-3022	30" x 30" x 22" H

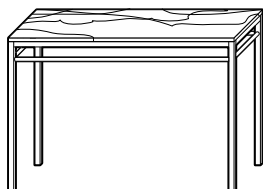

212M-4215	42" x 15" x 29" H
212M-4815	48" x 15" x 29" H

1/2" GLASS or COLORA TOP			3/4" GLASS or VENEER TOP			GLASS ADD CRATE NET \$	ADD SANDBLAST	ADD BRUSH STAIN	ADD POL STAIN
COLORA BASE			COLORA BASE						
QTY1	QTY3	QTY10	QTY1	QTY3	QTY10				
1731	1643	1558	2133	2026	1920	66	110	572	981
1933	1836	1741	2502	2376	2251	80	160	648	1082
2274	2161	2046	3050	2897	2745	94	218	702	1243
1774	1687	1597	2194	2084	1974	51	120	604	1004
1891	1797	1703	2419	2297	2176	64	147	648	1082
2170	2062	1954	2843	2701	2559	77	191	680	1174
2552	2425	2296	3567	3387	3209	107	282	809	1384
1491	1416	1342	1665	1582	1500	18	42	396	712
1506	1430	1356	1679	1594	1511	22	51	427	769
1595	1516	1436	1852	1759	1666	32	71	472	895
1763	1676	1587	2161	2053	1944	66	110	608	1039
1781	1691	1603	2187	2078	1968	36	82	614	1135
1829	1736	1645	2274	2161	2046	40	95	663	1183

MARBLE or GRANITE TOP			ADD CRATE NET \$	ADD BRUSH STAIN	ADD POL STAIN
COLORA BASE					
QTY1	QTY3	QTY10			
3300	3140	2970	95	572	981
4212	4053	3833	114	648	1082
5397	5238	5015	134	702	1243
3446	3283	3100	73	604	1004
3992	3830	3611	91	648	1082
4877	4717	4498	110	680	1174
6240	6054	5799	153	809	1384
1977	1879	1780	24	396	712
2161	2053	1944	30	427	769
2572	2444	2316	43	472	895
3326	3163	2994	95	608	1039
2866	2722	2579	48	614	1135
3033	2881	2730	54	663	1183

• Crating charges per top. Crating for Qty: 4+ will be quoted.

OCCASIONAL

215 PARSONS TABLES • GLASS, COLORA, WOOD TOP

1 1/2" x 1 1/2" square stainless steel frame. 1/2" or 3/4" clear or sandblast glass and 3/4" COLORA or veneer tops are flush or optionally raised over base.

Specify: model number - base finish - glass type and thickness or Colora color or veneer type - optional raised top

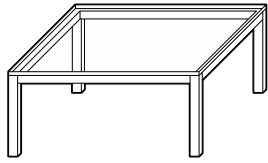

ITEM	DIMENSIONS
215-3030	30" x 30" x 16" H
215-3636	36" x 36" x 16" H
215-4242	42" x 42" x 16" H
215-4848	48" x 48" x 16" H
215-4024	40" x 24" x 16" H
215-4626	46" x 26" x 16" H
215-4830	48" x 30" x 16" H
215-5436	54" x 36" x 16" H

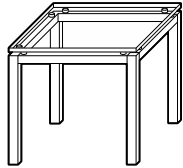

215-2022	20" x 20" x 22" H
215-2422	24" x 24" x 22" H
215-3022	30" x 30" x 22" H

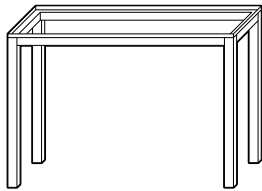

215-4215	42" x 15" x 29" H
215-4815	48" x 15" x 29" H
215-6018	60" x 18" x 29" H
215-7220	72" x 20" x 29" H

215 PARSONS TABLES • STONE TOP

1 1/2" x 1 1/2" square stainless steel frame. Marble or granite tops are **Square** edge and flush or optionally raised over base.

Specify: model number - base finish - marble or granite variety

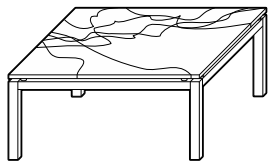

ITEM	DIMENSIONS
215M-3030	30" x 30" x 16" H
215M-3636	36" x 36" x 16" H
215M-4242	42" x 42" x 16" H
215M-4848	48" x 48" x 16" H
215M-4024	40" x 24" x 16" H
215M-4626	46" x 26" x 16" H
215M-4830	48" x 30" x 16" H
215M-5436	54" x 36" x 16" H

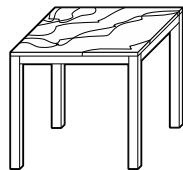

215M-2022	20" x 20" x 22" H
215M-2422	24" x 24" x 22" H
215M-3022	30" x 30" x 22" H

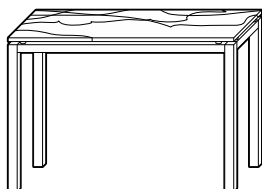

215M-4215	42" x 15" x 29" H
215M-4815	48" x 15" x 29" H
215M-6018	60" x 18" x 29" H
215M-7220	72" x 20" x 29" H

1/2" GLASS or COLORA TOP			3/4" GLASS or VENEER TOP			GLASS ADD CRATE NET \$	ADD SANDBLAST	ADD BRUSH STAIN	ADD POL STAIN	ADD RAISED TOP
COLORA BASE QTY1	QTY3	QTY10	COLORA BASE QTY1	QTY3	QTY10					
1576	1495	1417	1969	1870	1773	66	110	809	1360	248
1769	1681	1593	2340	2222	2106	80	160	862	1451	248
2116	2010	1905	2891	2746	2601	94	218	961	1522	248
2370	2251	2133	3383	3215	3045	107	282	1106	1768	372
1610	1529	1449	2031	1930	1829	51	120	840	1381	248
1730	1642	1557	2255	2142	2030	64	147	869	1457	248
2010	1909	1809	2687	2550	2417	77	191	910	1505	308
2206	2094	1985	3063	2909	2756	104	238	1005	1609	308
1351	1283	1216	1522	1447	1370	22	51	710	1213	248
1441	1370	1298	1694	1611	1525	32	71	773	1324	248
1610	1529	1449	2005	1905	1804	66	110	889	1478	248
1653	1569	1488	1931	1834	1737	36	82	884	1510	248
1708	1622	1536	2023	1922	1821	40	95	905	1547	308
1898	1804	1709	2375	2258	2138	57	132	1037	1705	308
2088	1984	1879	2720	2584	2448	76	178	1241	1968	308

MARBLE or GRANITE TOP			ADD CRATE NET \$	ADD BRUSH STAIN	ADD POL STAIN	ADD RAISED TOP
COLORA BASE QTY1	QTY3	QTY10				
3130	3038	2869	95	809	1360	248
4043	3952	3786	114	862	1451	248
5229	5137	4970	134	961	1522	248
6046	5953	5786	153	1106	1768	372
3274	3182	3014	73	840	1381	248
3734	3641	3474	91	869	1457	248
4708	4617	4450	110	910	1505	308
5647	5553	5387	148	1005	1609	308
1997	1906	1797	30	710	1213	248
2411	2317	2170	43	773	1324	248
3196	3073	2906	95	889	1478	248
2704	2614	2449	48	884	1510	248
2923	2830	2665	54	905	1547	308
3767	3674	3506	82	1037	1705	308
4607	4382	4348	109	1241	1968	308

• Crating charges per top. Crating for Qty: 4+ will be quoted.

OCCASIONAL

500 METAL DRUM TABLES

Seamless steel cylinders available in plated finishes. 1/4" protective clear glass is included.

Specify: model number - drum finish

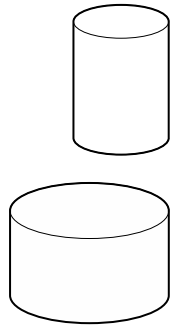

ITEM	DIMENSIONS
500-1818	18" dia x 18 1/2" H
500-1821	18" dia x 21 1/2" H
500-2215	22" dia x 15 1/2" H
500-2221	22" dia x 21 1/2" H
500-2421	24" dia x 21 1/2" H
500-3015	30" dia x 15 1/2" H

500G METAL DRUMS • GLASS TOP

Seamless steel cylinder with 3/4" clear or sandblast glass top, flush or raised over base.

Specify: model number - drum finish - glass type - if raised top, finish of steel risers

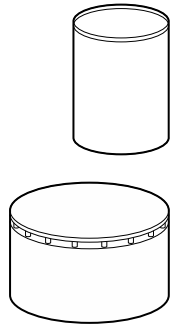

ITEM	DIMENSIONS	RAISED TOP HEIGHT
500G-1819	18" dia x 19" H	20" H
500G-1822	18" dia x 22" H	23" H
500G-2216	22" dia x 16" H	17" H
500G-2222	22" dia x 22" H	23" H
500G-2422	24" dia x 22" H	23" H
500G-3016	30" dia x 16" H	17" H

500M METAL DRUMS • STONE TOP

Stainless steel cylinder with marble or granite tops, flush or raised over base.

Specify: model number - drum finish - marble or granite variety - if raised top, finish of steel risers

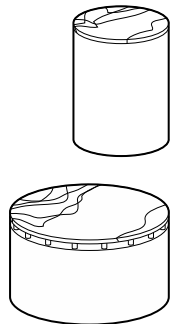

ITEM	DIMENSIONS	RAISED TOP HEIGHT
500M-1819	18" dia x 19" H	20" H
500M-1822	18" dia x 22" H	23" H
500M-2216	22" dia x 16" H	17" H
500M-2222	22" dia x 22" H	23" H
500M-2422	24" dia x 22" H	23" H
500M-3016	30" dia x 16" H	17" H

• Steel risers are in black, polished or satin chrome.

SATIN + POL CHROME
QTY1 QTY3 QTY10

2150	2043	1790
2387	2280	2023
2342	2237	1982
2731	2620	2361
3088	2976	2717
3654	3539	3266

3/4" CLEAR GLASS TOP

SATIN + POL CHROME DRUM
QTY1 QTY3 QTY10

			ADD CRATE NET \$	ADD SANDBLAST	ADD RAISED TOP
2449	2342	2089	18	37	289
2687	2576	2320	18	37	289
2775	2669	2415	32	51	347
3166	3052	2796	32	51	347
3618	3505	3248	32	64	374
4446	4329	4054	66	94	461

MARBLE or GRANITE TOP, SQ EDGE

SATIN + POL CHROME DRUM
QTY1 QTY3 QTY10

				ADD RAISED TOP
2573	2467	2214	24	621
2810	2702	2447	24	621
3003	2896	2643	43	776
3393	3281	3022	43	776
3838	3728	3470	43	916
4894	4780	4505	95	1248

OCCASIONAL

- Crating charges per top. Crating for Qty: 4+ will be quoted.
- QTY 1 shipments subject to extra packaging charges to be quoted.

550 VENEER and COLORA DRUM TABLES

Available in standard COLORA finishes or in wood veneers.

Specify: model number - Colora finish or veneer type

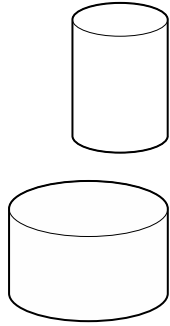

ITEM	DIMENSIONS
550-1818	18" dia x 18 1/2" H
550-1821	18" dia x 21 1/2" H
550-2215	22" dia x 15 1/2" H
550-2218	22" dia x 18 1/2" H
550-2221	22" dia x 21 1/2" H
550-2418	24" dia x 18 1/2" H
550-2421	24" dia x 21 1/2" H
550-3015	30" dia x 15 1/2" H
550-3021	30" dia x 21 1/2" H
550-3615	36" dia x 15 1/2" H

550G VENEER and COLORA DRUM TABLES • GLASS TOP

Same as 550 table except with 3/4" clear or sandblasted glass top, flush or raised over base.

Specify: model number - Colora finish, or veneer type - glass type - if raised top, finish of steel risers

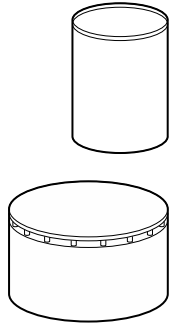

ITEM	DIMENSIONS	RAISED TOP HEIGHT
550G-1819	18" dia x 19" H	20" H
550G-1822	18" dia x 22" H	23" H
550G-2216	22" dia x 16" H	17" H
550G-2219	22" dia x 19" H	20" H
550G-2222	22" dia x 22" H	23" H
550G-2419	24" dia x 19" H	20" H
550G-2422	24" dia x 22" H	23" H
550G-3016	30" dia x 16" H	17" H
550G-3022	30" dia x 22" H	23" H
550G-3616	36" dia x 16" H	17" H

550M VENEER and COLORA DRUM TABLES • STONE TOP

Same as 550 table but with marble or granite top, flush or raised over base.

Specify: model number - Colora finish or veneer type - marble or granite variety - if raised top, finish of steel risers

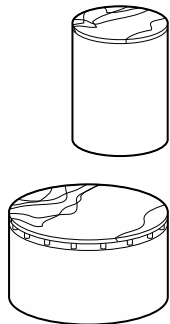

ITEM	DIMENSIONS	RAISED TOP HEIGHT
550M-1819	18" dia x 19" H	20" H
550M-1822	18" dia x 22" H	23" H
550M-2216	22" dia x 16" H	17" H
550M-2219	22" dia x 19" H	20" H
550M-2222	22" dia x 22" H	23" H
550M-2419	24" dia x 19" H	20" H
550M-2422	24" dia x 22" H	23" H
550M-3016	30" dia x 16" H	17" H
550M-3022	30" dia x 22" H	23" H
550M-3616	36" dia x 16" H	17" H

- COLORA and Veneer Drum diameters are nominal. Please call us for exact dimensions for C.O.M. glass or stone tops.
- Steel risers are in black, polished or satin chrome; Colora Drum Tables have matching steel risers unless specified otherwise.

COLORA DRUM VENEER DRUM					
QTY1	QTY3	QTY10	QTY1	QTY3	QTY10
1230	999	839	1733	1201	1042
1261	1028	867	1839	1287	1130
1334	1104	943	1743	1231	1081
1367	1135	977	1865	1330	1169
1401	1169	1009	1884	1357	1187
1507	1177	1117	1966	1426	1263
1545	1230	1154	2089	1529	1357
1730	1414	1337	2160	1638	1471
1839	1525	1449	2407	1861	1690
2016	1730	1642	3176	2799	2524

3/4" CLEAR GLASS TOP

COLORA DRUM VENEER DRUM						ADD CRATE NET \$	ADD SANDBLAST	ADD RAISED TOP
QTY1	QTY3	QTY10	QTY1	QTY3	QTY10			
1795	1561	1402	2295	1763	1608	18	43	308
1820	1591	1428	2400	1850	1691	18	44	308
1896	1665	1506	2309	1796	1643	32	65	372
1931	1698	1538	2426	1889	1731	32	65	372
1963	1732	1575	2438	1924	1763	32	65	372
2114	1801	1729	2573	2034	1869	32	79	401
2151	1839	1762	2699	2138	1966	32	79	401
2676	2363	2288	3110	2587	2424	66	121	494
2788	2475	2398	3357	2811	2639	66	121	494
3390	3102	3016	4552	4173	3901	80	161	569

MARBLE or GRANITE TOP, SQ EDGE

COLORA DRUM VENEER DRUM						ADD CRATE NET \$	ADD RAISED TOP
QTY1	QTY3	QTY10	QTY1	QTY3	QTY10		
1940	1732	1588	2394	1913	1771	24	308
1964	1757	1612	2489	1990	1847	24	308
2442	2236	2092	2815	2353	2216	43	372
2475	2266	2122	2922	2394	2248	43	372
2504	2295	2151	2932	2436	2283	43	372
2837	2552	2488	3249	2764	2615	43	401
2869	2587	2518	3362	2856	2701	43	401
3866	3583	3516	4255	3784	3636	95	494
3967	3682	3616	4477	3987	3832	95	494
4607	4333	4219	5759	5390	5115	114	569

• Crating charges per top. Crating for Qty: 4+ will be quoted.
 • QTY 1 shipments subject to extra packaging charges to be quoted.

OCCASIONAL

700 STAINLESS STEEL CUBE TABLES

Polished or satin stainless steel laminated on wood core with hand-filed seamed edges. 1/4" protective clear glass top is included.

Specify: model number - finish of stainless steel

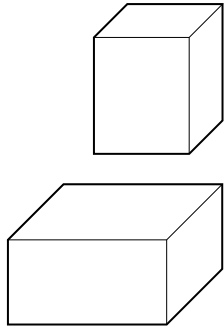

ITEM	DIMENSIONS
700-1818	18" x 18" x 18 1/2" H
700-1821	18" x 18" x 21 1/2" H
700-2215	22" x 22" x 15 1/2" H
700-2221	22" x 22" x 21 1/2" H
700-2415	24" x 24" x 15 1/2" H
700-2421	24" x 24" x 21 1/2" H
700-3015	30" x 30" x 15 1/2" H
700-3018	30" x 30" x 18 1/2" H
700-3021	30" x 30" x 21 1/2" H

700G STAINLESS STEEL CUBE TABLES • GLASS TOP

Same as 700 tables except with 3/4" clear or sandblasted glass, flush or raised over base.

Specify: model number - finish of stainless steel

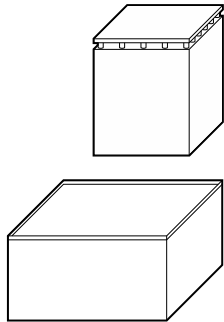

ITEM	DIMENSIONS
700G-1818	18" x 18" x 18 1/2" H
700G-1821	18" x 18" x 21 1/2" H
700G-2215	22" x 22" x 15 1/2" H
700G-2221	22" x 22" x 21 1/2" H
700G-2415	24" x 24" x 15 1/2" H
700G-2421	24" x 24" x 21 1/2" H
700G-3015	30" x 30" x 15 1/2" H
700G-3018	30" x 30" x 18 1/2" H
700G-3021	30" x 30" x 21 1/2" H

700M STAINLESS STEEL CUBE TABLES • STONE TOP

Same as the 700 tables except with marble or granite top, flush or raised over base.

Specify: model number - finish of stainless steel

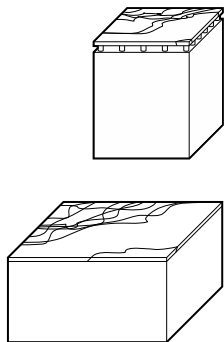

ITEM	DIMENSIONS
700M-1818	18" x 18" x 18 1/2" H
700M-1821	18" x 18" x 21 1/2" H
700M-2215	22" x 22" x 15 1/2" H
700M-2221	22" x 22" x 21 1/2" H
700M-2415	24" x 24" x 15 1/2" H
700M-2421	24" x 24" x 21 1/2" H
700M-3015	30" x 30" x 15 1/2" H
700M-3018	30" x 30" x 18 1/2" H
700M-3021	30" x 30" x 21 1/2" H

• Steel risers are in black, polished or satin chrome.

QTY1	QTY3	QTY10
1875	1764	1562
2002	1889	1687
2109	1998	1796
2409	2296	2093
2323	2211	2010
2644	2535	2332
3029	2922	2719
3228	3119	2917
3426	3315	3113

3/4" CLEAR GLASS TOP

QTY1	QTY3	QTY10	ADD CRATE NET \$	ADD SANDBLAST	ADD RAISED TOP
2092	1983	1781	18	36	347
2219	2107	1903	18	36	347
2434	2321	2118	32	51	461
2731	2621	2417	32	51	461
2709	2595	2394	32	58	461
3029	2919	2716	32	58	461
3628	3523	3320	66	94	577
3830	3720	3516	66	94	577
4028	3916	3713	66	94	577

MARBLE or GRANITE TOP, SQ EDGE

QTY1	QTY3	QTY10	ADD CRATE NET \$	ADD SANDBLAST	ADD RAISED TOP
2257	2145	1943	24		559
2383	2271	2067	24		559
2678	2568	2364	43		776
2977	2867	2662	43		776
2999	2887	2686	43		828
3320	3209	3007	43		828
4083	3976	3772	95		1135
4283	4173	3970	95		1135
4482	4371	4168	95		1135

• Crating charges per top. Crating for Qty: 4+ will be quoted.
 • QTY 1 shipments subject to extra packaging charges to be quoted.

OCCASIONAL

750 VENEER and COLORA CUBE TABLES

Available in COLORA finishes or in wood veneers.

Specify: model number - Colora finish or veneer type

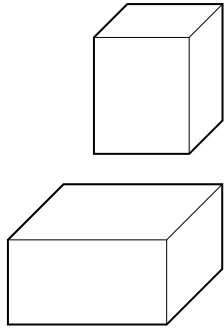

ITEM

DIMENSIONS

750-1818	18" x 18" x 18 1/2" H
750-1821	18" x 18" x 21 1/2" H
750-2215	22" x 22" x 15 1/2" H
750-2221	22" x 22" x 21 1/2" H
750-2415	24" x 24" x 15 1/2" H
750-2421	24" x 24" x 21 1/2" H
750-3015	30" x 30" x 15 1/2" H
750-3018	30" x 30" x 18 1/2" H
750-3021	30" x 30" x 21 1/2" H
750-3615	36" x 36" x 15 1/2" H

750G VENEER AND COLORA CUBE TABLES • GLASS TOP

Same as 750 tables except with 3/4" clear or sandblast glass, flush or raised over base.

Specify: model number - Colora finish or veneer type - type of glass - if raised top, finish of steel risers

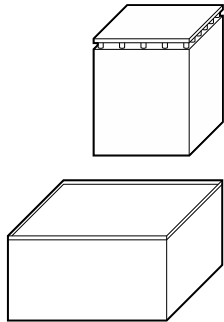

ITEM

DIMENSIONS

RAISED TOP HEIGHT

750G-1819	18" x 18" x 19" H	20"
750G-1822	18" x 18" x 22" H	23"
750G-2216	22" x 22" x 16" H	17"
750G-2222	22" x 22" x 22" H	23"
750G-2416	24" x 24" x 16" H	17"
750G-2422	24" x 24" x 22" H	23"
750G-3016	30" x 30" x 16" H	17"
750G-3019	30" x 30" x 19" H	20"
750G-3022	30" x 30" x 22" H	23"
750G-3616	36" x 36" x 16" H	17"

750M VENEER AND COLORA CUBE TABLES • STONE TOP

Same as 750 tables except with marble or granite tops, flush or raised over base.

Specify: model number - Colora finish or veneer type - marble or granite variety - if raised top, finish of steel risers

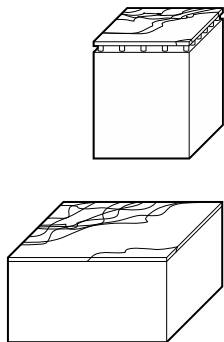

ITEM

DIMENSIONS

RAISED TOP HEIGHT

750M-1819	18" x 18" x 19" H	20"
750M-1822	18" x 18" x 22" H	23"
750M-2216	22" x 22" x 16" H	17"
750M-2222	22" x 22" x 22" H	23"
750M-2416	24" x 24" x 16" H	17"
750M-2422	24" x 24" x 22" H	23"
750M-3016	30" x 30" x 16" H	17"
750M-3019	30" x 30" x 19" H	20"
750M-3022	30" x 30" x 22" H	23"
750M-3616	36" x 36" x 16" H	17"

• Steel risers are in black, polished or satin chrome; Colora Cube Tables have matching steel risers unless specified otherwise.

COLORA CUBE

VENEER CUBE

QTY1	QTY3	QTY10	QTY1	QTY3	QTY10
933	742	613	1478	1093	937
981	788	647	1568	1185	1027
1029	835	652	1560	1165	988
1091	897	698	1726	1307	1127
1148	951	736	1652	1240	1054
1227	1030	802	1831	1401	1205
1396	1203	895	1826	1470	1241
1449	1256	937	2016	1535	1337
1492	1298	973	2093	1642	1436
1528	1333	1030	2108	1681	1488

3/4" CLEAR GLASS TOP

COLORA CUBE			VENEER CUBE			GLASS ADD CRATE NET \$	ADD SANDBLAST	ADD RAISED TOP
QTY1	QTY3	QTY10	QTY1	QTY3	QTY10			
1237	1041	916	1803	1417	1261	18	42	336
1283	1088	948	1895	1510	1353	18	42	336
1396	1204	1018	1961	1564	1388	32	64	449
1458	1283	1065	2120	1705	1527	32	66	449
1583	1388	1175	2122	1713	1532	32	72	449
1664	1469	1241	2305	1870	1678	32	73	449
2082	1887	1580	2567	2170	1982	66	115	561
2131	1953	1617	2697	2275	2078	66	115	561
2175	2013	1676	2835	2381	2173	66	115	561
2660	2463	2162	3239	2813	2616	80	132	673

MARBLE or GRANITE TOP, SQ EDGE

COLORA CUBE			VENEER CUBE			STONE ADD CRATE NET \$	ADD RAISED TOP
QTY1	QTY3	QTY10	QTY1	QTY3	QTY10		
1626	1432	1306	2062	1705	1560	24	336
1674	1479	1338	2145	1790	1644	24	336
2064	1869	1687	2481	2116	1954	43	449
2122	1949	1733	2633	2247	2081	43	449
2376	2183	1969	2764	2383	2210	43	449
2460	2390	2037	2930	2528	2349	43	449
3324	3129	2886	3618	3251	3076	95	561
3371	3194	2862	3742	3349	3166	95	561
3419	3254	2918	3864	3447	3254	95	561
3882	3688	3387	5594	5168	4971	114	673

• Crating charges per top. Crating for Qty: 4+ will be quoted.
 • QTY 1 shipments subject to extra packaging charges to be quoted.

OCCASIONAL



PRISMATIQUE

95 Wingold Avenue
Toronto, Ontario, Canada M6B 1P8

Phone 416 961 7333
Toll free 888 414 7333
Fax 416 925 3295

tables@prismatique.com
www.prismatique.com